

THE CUNY HSE CURRICULUM FRAMEWORK

SECTION 4 SECTION

Math: Problem-Solving in Functions and Algebra

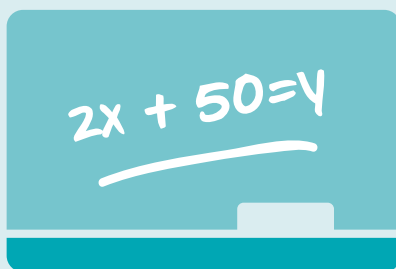

Contents	Overview: The CUNY HSE Math Curriculum Framework	3
	Curriculum Map	27
	Unit Descriptions	
	Unit 1: Introducing Functions (Lesson)	31
	Unit 2: Three Views of A Function (Teacher Support)	51
	Unit 3: Rate of Change/Starting Amount (Lesson)	69
	Unit 4: Systems of Equations: Making and Justifying Choices (Teacher Support)	101
	Unit 5: Nonlinear Functions (Teacher Support)	117
	Unit 6: Modeling Exponential Growth (Teacher Support)	133
	Unit 7: Equality (Teacher Support)	145
	Unit 8: Developing Algebraic Reasoning Through Visual Patterns	
	Introduction: More Than Solving for x	157
	Introduction to Visual Patterns (Lesson I)	163
	An Open Approach to Visual Patterns (Lesson II)	183
	A Sample Progression of Visual Patterns	196
	Unit 9: Using Area Models to Understand Polynomials (Lesson)	201
	Reflective Teaching	223
	Resources for Teaching HSE Math	257

The CUNY HSE Curriculum Framework

2015

Principal Authors

Kate Brandt *Social Studies: Integrating Reading and Writing Curriculum Framework*
Rebecca Leece *Science: Matter and Energy Curriculum Framework*
Mark Trushkowsky *Math: Problem Solving in Functions and Algebra Curriculum Framework*
Eric Appleton *Math and Science: Contributing Author and Curriculum Framework Production Coordinator*

Associate Author

Tyler Holzer, *Math: Problem Solving in Functions and Algebra Curriculum Framework*

Special Acknowledgement

Steve Hinds, for his visionary contributions to CUNY HSE math instruction.

Significant Contributions

Erna Golden, Shirley Miller

Acknowledgements

Ellen Baxt, Gary Dine, Arnitta McKinley, Joan Stern, Ramon Tercero, Kevin Winkler

Project Director: Leslee Oppenheim

Design and Layout: Renée Skuba | Graphic Design

Video Production: Kieran O'Hare, Zachary Timm

The authors would like to thank their students in the Spring 2015 CUNY HSE Demonstration Class who inspired their teaching and writing.

Sabrina Abreu
Adam Alicea
Janet Alicea
Netea Banks
Eileen Berrios
Asbury Brown
Tiffany Carrian

Fabio Castro
Iquis Dickerson
Sandra Eisenberg
Julien Fils
Renee Gulliver
Brad Lee
Ron Lee

Edith Leon
Lashana Linton
Angel Osorio
Roxanne Perez
Miyako Smith
Natasha Williams

The City University of New York, Office of Academic Affairs

John Mogulescu

Senior University Dean
for Academic Affairs and
Dean of the School of
Professional Studies

Suri Duitch

University Dean for
Continuing Education and
Workforce Development

Leslee Oppenheim

University Director of
Language and Literacy
Programs

For information about the CUNY Adult Literacy/HSE Program—its services, educational curricula and instructional materials, or to inquire about training options, please contact CUNY's HSE Professional Development Team at:

<http://literacy.cuny.edu>

This project was made possible through WIA Incentive Grant funding from the U.S. Department of Labor, with support from the New York State Department of Labor, Division of Employment and Workforce Solutions, in collaboration with the New York State Education Department, Office of Adult Career and Continuing Education Services.



Department
of Labor



CUNY The City
University
of
New York

This work is licensed under a Creative Commons Attribution 4.0 International License.

This workforce solution was funded by a grant awarded by the U.S. Department of Labor. The solution was created by the grantee and does not necessarily reflect the official position of the U.S. Department of Labor. The Department of Labor makes no guarantees, warranties, or assurances of any kind, expressed or implied, with respect to such information, including any information or its completeness, timeliness, usefulness, adequacy, continued availability or ownership. CUNY is an equal opportunity employer/program and auxiliary aids and services are available upon request to individuals with disabilities.



Math: Problem-Solving in Functions and Algebra

Overview

Defining Math and Mindset

Imagine traveling alone in a country where you don't speak the language. Maybe you learn a few words like “please” and “thank you” (and become more polite than you are in your native language). Maybe you memorize a whole sentence. You're not sure what it means, but you know if you say it at the right time, people smile. But if you say it at the wrong time, people seem annoyed or disappointed. You can't for the life of you figure out what is the right or wrong time to say it. Slowly, the isolation takes over and leaves you rigid and anxious. It is an anxiety that comes from hearing everyone around you speaking a language you don't know, that is different from the one inside your mind. You can feel like you've lost your identity, like you have no sense of agency. You can't express who you are and it can feel like you are not really there.

Unfortunately, when it comes to math, this experience (and resulting mindset) is how many adult students feel when they enter our classrooms. At the root of this alienation is the way students define math and mathematical learning.

HOW DO ADULT EDUCATION STUDENTS FEEL ABOUT MATHEMATICS?

- Math is a club where only certain people—“math people”—are allowed, and I am not one of them.
- Math is a set of procedures that make no sense that you just have to memorize.
- Math is something you learn by sitting passively and watching someone do a procedure on the board.
- Math is about getting the answer.
- All you need to do is learn all the formulas and you will understand math.
- Doing math means repeating that same procedure to answer 15-25 identical problems.

Sections:

- Defining Mathematics
- Six Core Teaching and Learning Principles
- Basic Structure of a Math Lesson Plan
- Powerful Routines for Math Classrooms
- How the Math Section Works

- Being good at math means being fast.
- Understanding math means getting all the answers correct.
- Math is something that doesn't have to make sense—if you know the keywords, they will tell you what to do.
- Math has little to do with “me” (except in terms of money).
- Math has nothing to do with communication, creativity or intuition.
- There is one right way to solve a math problem—so if you don't know it, you might as well put down your pencil and wait for the teacher to show you.

Not all of our students feel this way about math, but many of them do. And there is a strong correlation between students who believe these statements and students who have real problems and unproductive struggle with math.

How is it that students from all across the U.S. and from countries all over the world have the same misconceptions about what it means to do, learn and understand math? It has to do with the way almost all of us were taught math. Not many of us had teachers who told us those things explicitly (though I have heard some stories). But still the message got across through the way we were taught. Even those of us who were successful in our own math education are not necessarily immune.

It is telling how many adult education math teachers say they are learning more math as teachers than they ever did in school. That statement really says a lot about how adults (and people in general) learn math. As teachers, we not only have to work on math problems, but we need to find engaging ways to talk about mathematical concepts. We need to find different strategies and ways to represent and explain things when students aren't understanding. We need to try to understand each student's reasoning, both when it is correct and when it is not. Each of those aspects of teaching are activities at the heart of what it means to do and study mathematics.

Mathematics is an “interconnected body of ideas and reasoning processes... [learned through] collaborative activity in which learners are challenged and arrive at understanding through discussion.” (Swan, 2005)

There is a lot we can do through the choices we make as teachers. We can give students the genuine experiences they need to reshape the harmful preconceived notions of what math is and who they can be in a math classroom. For example, we can present problems before showing students how to solve them. By putting the problem before the explanation, we put student thinking and reasoning at the heart of our lessons. We convey to students that math can come from them, that they can develop strategies for working on problems they've never seen before.

One classroom routine that can get students to question the idea that math is just a set of procedures to be memorized is an activity called, “*Sometimes, Always, Never*.” The basic idea is you give students a mathematical statement and ask them to categorize it as always being true, sometimes being true or never being true. If it is true, students have to give an example, and if it is not true (or not always true), they need to provide a counterexample. For example, you might ask students to consider, “Difference means subtraction.” This statement is sometimes true, but not always. A counterexample might be, “There is a 35 year age difference between Paulina and her son. If Paulina’s son is 8, how old is Paulina?” Students who think “difference” always means subtraction will subtract 8 from 35 and say that Paulina must be 27. “*Sometimes, Always, Never*” is an important activity to do multiple times over the course of a semester. The more you do it, the more you will see your students bring the question to other aspects of your class—when learning a new content, when considering a classmate’s strategy, they’ll begin to question the boundaries and exceptions of mathematical statements. For more on this idea, look for the article “13 Rules that Expire” cited in the math resources section.

STUDENT MISTAKES ARE EXPECTED, RESPECTED AND INSPECTED

Students tend to think of mistakes in math as failures and as proof that they “are just not good at math.” For teachers, when student mistakes or misunderstandings come out, it can be tempting to move past them as quickly as possible. Teachers often keep calling on different students until the correct answer comes out. As an alternative, what if we asked questions designed to draw out those common mistakes and misconceptions? What if we treated student mistakes like the discoveries they are and framed them as opportunities for everyone to learn something? We need to hear from students who don’t know the answer, as much as we need to hear from those who do. A mistake that is not addressed is usually a mistake that will be repeated. A student mistake can also serve as a “canary in a mineshaft”—if one student is capable of making it, others might as well, even if they didn’t this time.

For more on how to use student mistakes, check out the following reviews on CollectEdNY.org:

- <http://www.collectedny.org/2015/03/my-favorite-no-a-great-way-to-celebrate-student-mistakes-in-math/>
- <http://www.collectedny.org/2015/04/mistakes-in-math-expected-respected-and-inspected/>

A FINAL WORD ON WHAT IT MEANS TO DO MATH

The Common Core Mathematics Standards are composed of two parts of equal importance. The content standards address what math content students should learn at different grade levels. The 8 Standards for Mathematical Practice (MP), are a redefinition and a guide for what it means to do math and what it means to be a mathematically proficient student. The 8 MPs are what students should be doing in math classes at every level, with whatever content they are learning. Phil Daro (2015), one of the writers of the CC math standards has said the MPs are a way to define the content of students mathematical character. Too many of our students say, “I am not a math person.” They say that because to them, being a math person means already knowing the math content. The 8 Standards of Mathematical Practice are a way of redefining what it means to be a “math person”—it’s not how much math content you know, but more about your attitudes and what you do to make sense of and learn math. The 8 MPs define the way mathematical knowledge comes together and gets used, as well as productive attitudes and habits of mind in the study of math. The math lessons and activities in this curriculum framework offer ample opportunities for students to explore all 8 Math Practices.

Underlying Teaching and Learning Principles

The following research-based teaching principles are at the center of the work we do at the CUNY Adult Literacy and High School Equivalency Program. These principles informed all of the work in this document, from the content selection down to the design of each problem.

CORE PRINCIPLE #1

Implement a Content-Based Approach

“The model of the student as an empty vessel to be filled with knowledge provided by the teacher must be replaced. Instead, the teacher must actively inquire into students’ thinking, creating classroom tasks and conditions which student thinking can be revealed. Students’ initial conceptions then provide the foundation on which more formal understanding of the subject matter is built.”

– from *How People Learn: Brain, Mind, Experience and School* (2004)

TEACH DEPTH OVER BREADTH

We need to teach with Focus and teach less, so students can learn more.

One of the biggest challenges we face in adult education math instruction is the amount (and difficulty) of material we feel pressured to teach and that students are expected to learn. All teachers want what is best for their students and sometimes it feels like we should try to cover as much as possible, to give them a taste of everything they might see on their HSE exam.

Now more than ever, it is important to remember both the short-term and the long-term learning goals we have for our students. Both the Common Core and the research back up what our experience tells us. When students receive instruction that is “a mile wide and an inch deep,” they often lack the ability to apply what they know to new

situations, or remember what they’ve already “learned.” Many of us have asked ourselves questions like, “My students knew how to do this two weeks ago, what happened?” or “Why don’t my students see that they can use what we learned to solve that problem to solve this one?” The answer to both questions is the same: *Without a deep enough understanding, students won’t transfer what they know to new situations or to retain what they do in class.* It may feel strange to spend more time on fewer topics, but if we try to cover everything, we end up having to re-teach things anyway, often right in the middle of a lesson on a completely different topic.

“You can’t make a plant grow by pulling on it, you only make it rootless.”

—Student

We should accept that we cannot teach everything and then make some choices about how we will focus our resources, especially our time. We should not let any assessments work us up into such a panic that we lose sight of some of our greatest strengths—our practice of starting from where students are and our serious respect for their learning processes. As a student once told me, “You can’t make a plant grow by pulling on it, you only make it rootless.”

The math problems students will see on their HSE exams will be far more complex than what we find in workbooks and what was on the old G.E.D. Just knowing formulas will not be enough. Experience with routine problems that can be answered simply by using a memorized set of procedures or steps will not be enough. At the heart of teaching with focus is time. We need to give students time. Time to work on and struggle with complex problems. Time to present different solution methods. Time to discuss, appreciate and analyze each other’s methods. Time to debate and to write in math class. Time to revise their work. Time to reflect on what they are learning, what they understand, how they understand it and what questions they still have. Students feel great urgency to find shortcuts and move quickly to the test. It is our responsibility to slow the classroom down so that people learn the content.

There are several examples of the “teach less, learn more” philosophy working. Here is one:

The TIMSS (Trends in International Mathematics and Science Study) is one of those international tests you often hear about, on which students in the US do not perform particularly well. Because it is an international test, it is not written to favor one country’s curriculum over another. In fact, the curriculum in Singapore only covers 45% of what is on the TIMSS test. The U.S. curriculum covers 80% of what is on the TIMSS test. And yet students in Singapore were number 1 in the world on the TIMSS, while the

U.S. was in the middle of the pack. In this case, U.S. students may have covered more topics, but they did not develop a deep enough understanding to transfer it to different problems. The students from Singapore were not hurt by the fact that they learned less than half of the content on the TIMSS assessments. The student from the US may well have been hurt by curricula that tried to cover too much too quickly.

In the spirit of narrowing how much content we cover, this curriculum framework targets functions and algebraic reasoning. Concentrating on these topics allowed us to create a greater coherence between the topics and to go deeply into some high yield topics that will position students for mathematical success on their HSE exams, college, career and life. Focusing deeply on the major concepts in these two topics will allow students to secure the mathematical foundations, conceptual understanding, procedural skill and fluency, and ability to apply the math they have learned to solve all kinds of problems—inside and outside the math classroom.

AIM FOR COHERENCE

Teaching with coherence means that each lesson is not a new event, but builds on the knowledge students bring to each activity/concept/class. It also means making explicit connections between math topics, problems, and solution methods. Limiting the math we teach, focusing on high yield content allows us the time we need to help students develop an understanding of the structure of mathematics as a discipline, which helps with both retention and transference. Aiming for coherence means helping students understand how things fit together—and that they are related in the first place.

CORE PRINCIPLE #2

Provide Scaffolded Instruction

We need to start where our students are, or we run the risk of leaving them behind. Teachers of adult math learners often have to contend with “mixed-level” classrooms—classrooms with a dramatically wider range of student abilities than are generally found in the other subject areas. Sometimes, the mixed-level can even be embodied in a single student. You might have an immigrant student who is very good at calculations, but who struggles with word problems. You might have a student who

works in construction and can solve complex problems involving volume and operations with fractions, but who can't read a graph. At the core of our scaffolded math instruction are rich, non-routine problems that can be approached with a wide variety of student methods, from drawing pictures, guess-and-check and writing equations. Teachers prepared with support questions and extension questions can keep an entire class of “mixed-level” students working on the same problem and engaged in the productive struggle at the heart of each student’s proximal zone of development (ZPD). ZPD is a concept developed by Lev Vygotsky that looks at three kinds of learner experiences—there are the things that can do without help, there are the things they can't do and there are the things they can do with some guidance. The third category is the ZPD and where learning happens. We offer students problems that have a low entry and a high ceiling. A problem is a “low entry” if it is accessible to wide range of different different students, where every student can begin and find their own level of engagement. It has a “high ceiling” if there are a lot of possibilities for students to get into challenging mathematics, where the problem can be extended for students who need to be challenged further in order to say in their ZPD. The lessons, teacher supports and additional resources to follow are all built around these types of problems.

People learn math best when they can start with intuitive understandings, move into concrete manipulation, then into representational, and finally abstract and communicative levels of understanding and discussing mathematical concepts (Sharma, 1988).

Here's an example of a scaffolded progression:

In exploring how multiplication is about sets or groups, a teacher might start by flashing a photo of a carton of eggs and asking the class how many eggs they saw. Students will easily say 12. Did you count them all? No, I just knew that eggs come in a dozen. This is the intuitive level.

The next step may be to show a baking tin full of 12 muffins in 3 rows of 4 each. If we ask students to tell us how many muffins are there without counting each individual muffin, then ask how they know, they may say that there counted by 3's or counted by 4's or a student may say that there are 3 rows of 4, so they multiplied 3 times 4. This is the concrete level.

The next question may ask students to use colored tiles to create as many rectangles as they can with 12 tiles. Students may show rectangles formed of these dimensions: 1×12 , 2×6 and 3×4 . This could also be considered the concrete level.

A next question may ask students to use grid paper to draw rectangles with 24 squares (also concrete), but then ask for a number of squares that can't be drawn on the given grid paper. The resulting drawing of, say, a rectangle 60 squares tall and 20 squares wide would become representational, since it would no longer be efficient to count every square.

Finally, a symbolic relationship between the length, width and the area could be discovered: **length \times width = area**. This is a representational level of understanding.

Each of the steps from intuitive to concrete to representational to abstract are scaffolds for students' thinking. Some students may need intuitive and concrete ways of thinking more than others in order to understand the concepts, but the opportunity for all students to use these ways of thinking and to communicate with each other about them deepens everyone's knowledge and helps prepare students for abstract thinking.

Our principle of providing scaffolded instruction is explored further in the Lessons, the Teacher Supports and especially in the Adaptation section.

CORE PRINCIPLE #3

Stimulate Active Learning

ENGAGE STUDENTS IN PRODUCTIVE STRUGGLE

Look up "Perseverance" in the dictionary and it will say something like:

"To persist in or remain constant to a purpose, idea, or task in the face of obstacles or discouragement."

In order for students to develop perseverance in mathematical problem-solving, they have to learn how to work through struggle. They have to build up some experiences of feeling stuck, sticking with it and having a breakthrough. They will not be able to do this if we step in too soon or too often.

I like to think of our role as teachers as similar to that of a weight-lifting spotter in a gym. If the spotter keeps their hands on the weight and just lifts, he or she will be the one who gets stronger, not the weight lifter. A good spotter watches the person lifting weights and lets them do the work. When the lifter gets stuck, the spotter offers words of support and encouragement. If the lifter still can't proceed, the spotter helps, just

enough to get them past, sometimes only using a few fingers, and does the least amount of lifting they can. The spotter keeps the lifter able to work and develop beyond instances of struggle. It may be helpful to think of our work with students in a similar way. You can't get stronger or develop perseverance watching someone else lift weights. Students have to learn to work through struggle, not stop and wait for someone else to do the work when they get stuck. As a general rule, we should try to never take the pencil out of a student's hands.

This can be one of the hardest things for us as teachers to do. It can be tempting to just show students how to solve a problem as soon as they get stuck. It is often what they want us to do and if we do show them, they will be thankful and happy, which makes us feel great. But when we do that, what are we teaching them about their ability and independence? How are we preparing them to keep going the next time they struggle?

We should be honest with our students and tell them that we are preparing them for HSE exams and college and life, all of which will give them problems they've never seen before. In math class, we need to build our tolerance to uncertainty and struggle. We need to separate ourselves from the notion that math problems are like sitcom problems, solved quickly and neatly to perfect resolution. Our students need to understand that struggle is not a bad thing. Too many adult students interpret struggle as a deficit on their part. As soon as they start to struggle, they put down their pencils and say things like, "I just don't get it. I'm not good at math." Reacting to struggle that way makes it more difficult to learn, since working through struggle is a necessary part of the learning process.

When students are struggling, we should aspire to only ask them questions—and to ask as few questions as it takes to get them moving on their own.

- When students ask a question about one of the conditions that make the problem “problematic”, encourage them and reflect question back to them
- Answer most questions with *“Good question. What do you think?”*
- When students start to shut down, get them talking. Ask them to describe the situation in their own words. Ask them what they've tried so far.
- When students are stuck, suggest a strategy—for example, *“Can you draw a picture?”* or *“What could the answer be? Is there a way you can check that? What have you tried from our list of problem-solving strategies?”*

CHALLENGING, NON-ROUTINE PROBLEMS

“A problem is defined...as any task for which the students have no prescribed or memorized rules or methods, nor is there a perception by students that there is a specific correct solution method.” –Hiebert (1997)

The problems found in the math framework fit the above definition and the criteria for a good problem below:

- The problem should allow for different approaches/solution methods.
- The problem should have a low entry and a high ceiling, meaning it should allow for students at different levels to approach the problem in a way that makes sense for them (you might have a lower level student who is able to work on the problem drawing a picture, whereas a more advanced student might create a chart or an equation).
- Students should be unable to proceed immediately towards a solution.
- It should promote discussion, both of different approaches and of targeted math concepts or problem-solving strategies.

Many teachers have gotten the message that the Common Core and HSE math is more rigorous and more difficult than what students faced on the GED. This increased rigor is often understood as more advanced mathematical topics. This is only part of the story. The other part of the story is that students are going to need to face problems that will require them to make choices, try different things, change course if necessary, adapt and be flexible in their thinking and know for themselves when they are done and if they are correct. Instead of being centered around worksheets where students are answering a lot of questions, this framework is built around students working on one problem at a time. The problems allow for teachers to bring in formal mathematics after students have brought their rich thinking, sense-making and communication to bear. The problems are designed to draw the mathematics out of our students and build from there.

CORE PRINCIPLE #4:**Facilitate and Plan for Collaborative Learning**

“No matter how kindly, clearly, patiently, or slowly teachers explain, teachers cannot make students understand. Understanding takes place in students’ minds as they connect new information with previously developed ideas, and teaching through problem-solving is a powerful way to promote this kind of thinking. Teachers can help guide their students, but understanding occurs as a by-product of solving problems and reflecting on the thinking that went into those problem solutions.” –Diana Lambdin

EMPHASIZE METHODS OVER ANSWERS

Learning math is a collaborative activity. This includes group work and student presentations. After students work on a problem, we shift our attention to exploring our methods. While you are interacting with students during their group work, be on the look out for which strategies you’d like to discuss and start thinking about the order in which you want those presentations to go. In general, you want to look at the more concrete strategies first and then move towards the more abstract ones. Start with the strategy that you think is most accessible to all of your students and then look at the ones that connect to the specific math content you want to explore.

Students tend to think that math ends once you have the answer. We can help them see beyond that by taking seriously the learning that happens after students already have the answer to the problem. It is not uncommon for student presentations and the discussion of different solution methods to take just as long as it took for students to work on the problem, if not longer. There is a lot of mathematics to be learned after the problem is done. If we honor that, students will learn to honor it as well. And once they realize how much they get out of the discussions, it can make a large impact in their ideas about how people learn mathematics.

When students present their strategies, we want other students to engage with them. We want to help students make their thinking understood and we want other students to understand the thinking of their classmates.

Here are some questions that can help achieve these goals:

- Constantly ask, *Can you show us how you did that?*
- When a student presents their thinking and part of their reasoning is unclear, ask them to tell the class more about what they did there.
- When students present their thinking, give other students an opportunity to ask questions—if they don't have any, ask at least one question. You can also ask the rest of the class questions about the strategy. You want them to realize that being able to explain what was done in their own words is the threshold for understanding.
- After a student explains their thinking, ask someone else in class to explain a potentially confusing aspect of the student's thinking.
- After a presentation, ask students to turn to a partner and take 2 minutes to talk about something they appreciate about the strategy. Share out afterwards, having students speak directly to the student(s) whose strategy they are appreciating.
- Once a few strategies have been discussed, you can start asking questions like, *How are these strategies different? How are they similar?*

Help everyone realize who they should be listening to during student presentations. One strategy is to sit down in the seat of the student who is presenting. This will take the focus off of you, as the teacher. Let students do the talking, including clarification of their ideas.

FOCUS RESPONSIBILITY WITH STUDENTS.

- Don't exert authority by saying what is right or wrong.
- Respond to most student explanations with, *What do the rest of you think?*
- Ask, *How do we know this answer is correct?*
- Model thinking and powerful methods. When students have done all they can, the teacher can demonstrate other approaches. If this is done at the beginning, however, students will simply imitate the method and not appreciate why it was needed. Whenever possible, teachers should draw from presented student work.

CORE PRINCIPLE #5**Make Time For and Encourage Metacognition and Self-Regulated Learning**

We need to give students time to reflect on their sense-making process. After doing math (working on problems, discussing those problems and analyzing different strategies), students need time to pair share and/or write to help them think about what happened. You can have students write in math journals, or you can give them exit tickets, with the few questions you want them to respond to. Either way, you want to collect the responses as often as you can, provide feedback and return them to students.

Here are some examples of things you want students to be thinking about:

- What was challenging about this problem? Where did you get stuck? What did you do when you got stuck?
- What strategies worked for you?
- What was the best mistake you made today? What did you learn from that mistake?
- How did you get started on the problem?
- How is this problem similar to other problems we have worked on?
- What was the best question asked in class today—it could have been asked by you, another student or the teacher. How did that question help you?
- What do you want to remember about your work on this problem?
- What are two things you want to remember about today's class? What questions do you still have?
- How do you think what we did today is connected to what we were doing last week?
- If you could go back in time to the moment before you started working on this problem, what advice would you give yourself?
- What did you learn from working on this problem? What did you learn from explaining your strategy? What is one thing you learned from someone else's strategy?

- What did <student's name> do to help make her thinking and strategy clear to us?
- What general problem-solving strategies can we add to our class list?
- In ten sentences, summarize what we did today for a student who is not here.

When appropriate, we also want students to know why we are making the choices we are making as teachers. When we discuss different solution methods and go from concrete to more abstract, we can tell students we do that because that is how people learn (and ask them how it felt). When students ask us if their answer is correct and we answer by asking them, “What do you think?”, we should explain that we are not trying to frustrate them, but instead to help them be independent and develop their ability to judge the validity of their answers.

CORE PRINCIPLE #6:

Problem-Solving Strategies are Integrated into Content Learning

In addition to the math content, we want our students to build a toolbox of problem-solving strategies. We want students to think of these strategies as things they can do to help themselves make sense of challenging problems. These strategies help with perseverance when we frame them as “things you can do when you have no idea what to do.”

SOME EFFECTIVE PROBLEM-SOLVING STRATEGIES:

- Draw a picture/Make a visual representation
- Organize your thinking/Make a chart
- Guess and check
- Work backwards
- Act it out
- Work on a similar and simpler problem
- Use a model
- Create an equation

 To see the classroom video, **Respecting Problem-Solving Strategies: The Handshake Problem**, visit the CUNY HSE Curriculum Framework web site at <http://literacy.cuny.edu/hseframework>.

Basic Structure of a Math Lesson Plan

Here is the basic structure that each of the lessons and teacher supports in the math section follow.

1 Launch

Math lessons begin with a launch, which prepares students for the core problem of the day. The launch can be a discussion, writing assignment, open-ended question, photograph, video, or anything else that helps get students thinking about the context of the problem to come. It should be accessible enough that every student feels comfortable contributing.

2 Problem-Posing

Teacher engages students in a task. This might just be giving out the core problem. It might be giving students the situation—without the actual math problem/question—and asking them to create a visual representation of the situation. It might be giving students a problem and a list of problem-solving strategies and asking students to circle all of the strategies they think might be helpful in making sense of the problem.

3 Student Work

Students have the opportunity to work on their own at first, and then in groups. The first phase of the student work is their engaging with the problem. The second phase is having students work out how they are going to explain what they did to the rest of the class. I learned a great process for this from Billy Wharton, a New

York City teacher. Billy gives students pieces of newsprint/butcher paper to work on and has them fold the paper in half. On one half, they do all of their work—this is the messy side. On the other half, they rewrite and add labels to their process so that it will be clear to others during their presentation. Many students will need to do this several times before they get better at it.

4 Student Presentations and Debrief

Students present their reasoning and problem-solving process to their classmates and analyze each other's work.

5 Teacher Summary

This is an opportunity for teachers to make explicit connections to the mathematical content objectives for the day and student work on the core problem. This is when teachers might introduce vocabulary and formal notation (*"You know that relationship you noticed? Well, in mathematics there is a name for it..."*). It is also a moment where a teacher might speak to particular mathematical habits of mind they saw that they want to celebrate.

6 Reflection

Students are given time to look back over the day's class. It is a moment for students to consider what they did and be explicit about what they learned. Whatever form the reflection takes, teachers can use this reflection as a final formative assessment for day.

Powerful Routines for the Math Classroom

Here are three rich and rewarding math routines that teachers can incorporate into their daily instruction. They are all adaptable and can be used with any kind of content. See the web-based resources at the end of the math section for more of these kind of activities/routines.

NUMBER TALKS

Number Talks are something teachers can do as a warm-up in the beginning of class to help students build computational fluency, number sense and mathematical reasoning. Number talks don't need to be longer than 5-15 minutes and can be done with students at any level.

It starts with a problem or a question posed by a teacher.

Which is greater, 86×38 or 88×36 ?

Are there more inches in a mile or seconds in a day?

What is 25×29 ?

But, before you pick up your pencil, try to figure out the answer in your head. It makes it a much more interesting problem.

Number Talks emphasize mental math because the goal is to get students to perform operations with numbers in ways that are meaningful to them, as opposed to just following memorized procedures.

Even the most straight forward looking calculation can have multiple solution methods, especially if you have to calculate it mentally. Before you read any further, take a moment to multiply 18×5 in your head.

How did you do it?

- Did you do $9 \times 5 + 9 \times 5$?
- Did you do 10×9 ?
- Did you do $5 \times 10 + 5 \times 8$?
- Did you do $5 \times 20 - 5 \times 2$?
- Did you the standard procedure: 8×5 is 40, write the 0, carry the 4, and then 5×1 is 5 plus the 4 is 9?

If we wrote it out by hand, most of us would be far more likely to use the last method. Having to do it in our head encourages us to use our number sense.

The goal of number talks is for students to develop computational fluency. In order to do that, they need to understand certain mathematical concepts like the fact that the numbers are composed of smaller numbers and can be taken apart and combined in different ways.

You can do number talks in a variety of ways, but here's one possible format:

- 1 Give the students the prompt. Write it on the board, write it on a large piece of newsprint and hang it on the wall, project it.
- 2 Give students a few minutes to work on the problem in their heads. Tell them beforehand to give a thumbs up when they have an answer. You want to give all students the full amount of time to work on it, without the pressure of competing with quicker students.
- 3 Ask students to share their answers. Write them up on the board without indicating which (if any) are correct.
- 4 Ask a few willing students to share their method for mentally calculating their answer. A student does not need to have gotten as far as an answer to share their approach with the group. As students share, teachers write down what they are saying.

Check out the resource www.mathtalks.net to learn more about *Number Talks*.

USING GRAPHS IN MATH CLASS: OPEN-ENDED ACTIVITIES

Data and graph reasoning skills are vitally important in math, both in terms of HSE assessment and in the real-world and workplace. These skills are also essential in science and social studies. Below you will find eight effective strategies for developing these skills with your students.

- Before handing out the graph, announce the title to your students and have them make written or verbal predictions about what they think the data will show. After giving them the graph, compare the class predictions to the actual data. This is a great way to engage student interest and/or prior knowledge.

I am about to show you a data set titled “Life Expectancy in the U.S. 1900-2000”. What do you expect the data will show?

- Give your students the graph/chart without any attached questions, and ask them to write and talk about what they notice about the data. This is a good approach with all students, and particularly so for lower-level students who feel less confident about reading graphs. When we attach questions to a graph, students will often narrowly focus on those questions and they fail to consider the graph more broadly.

What do you notice?

What do you see that interests you? What do you want to know more about?

What do you have questions about?

- Ask your students to create true and false statements about the data in the graph. Students can try and stump one another by reading their statements and challenging others to decide if the statements are true or false.

Write three true statements based on this data.

Write two true statements and two false statements based on this data.

- Ask your students to write questions that could be asked and answered based on the data. (If you do this, it is a good idea to take their submissions and create a handout from it for a later class. When you use student questions, identify them by name beside each one.)

 To see the classroom video, **Graphs Tell a Story: Using Data to Understand the Past**, visit the CUNY HSE Curriculum Framework web site at <http://literacy.cuny.edu/hseframework>.

Create three questions that can be answered using information from the graph.

- Ask your students to write a few sentences in a journalistic style that describes the data. Encourage students to write more about trends in the data rather than to report a series of individual pieces of data.

You work for a newspaper. Your editor wants a short article describing the history of executions in the United States. Write a few paragraphs that describe executions in the United States from 1930 to 2005. Assume the reader cannot see the graph.

- Give your students a graph without a title and ask them to come up with their own title. This requires students to convey an overall impression of a set of data in a few words. This works best if you encourage creative titles that might be used in a newspaper, and not titles that merely repeat the axes labels.
- Particularly for data over time, ask students to make predictions for the future based on the trends observed in the data. Insist that students defend their predictions with calculations using those earlier trends. Discourage predictions based on hunches and background knowledge.
- Ask your students to debate an issue and create graphs to support their position. You might break the class into three groups—factory workers, middle management and CEOs. Give them the salaries for each position and ask each group to design a graph to present their recommendations.

WHY OPEN-ENDED DATA AND GRAPH ACTIVITIES?

Open-ended activities allow students to engage with the graphs at their own level as they do rich work interpreting graphs. These kinds of activities can be particularly effective in math classrooms where there is a wide range in student abilities. They emphasize students taking responsibility for the information that is central to the discussion, and develop student ability to speak and write in precise mathematical statements. Also, because these activities offer a lot of room for student interests to come out, they often pave the way to follow-

up graphs and/or data to pursue those interests further. Because the direction comes from the students themselves, students call upon their life experiences and they can see how math connects to things that they care about, not to mention the other HSE content areas.

Our role as teachers is to help students verify their observations and the observations of their peers. We can also ask follow-up questions to help students go deeper into the stories to be found in every graph.

WRITING IS THINKING

Writing is an important aspect of math instruction. Below are some examples of prompts that can generate rich student writing in math class.

Prompts to Reveal Preconceived Notions/Initial Conceptions

- We can ask students to write about what they think/know about a math concept:

What I know about <math topic> so far:

Questions I have about <math topic> are:

- We can ask students to compare related mathematical concepts:

How are multiplication and division similar? How are they different?

How are fractions similar to decimals? How are they different?

Sample Social-Emotional Learning Prompts

- We can ask students to write about math/school in personal terms:
 - *What is the best way to learn math? Explain why you think so.*
 - *Who/what has influenced the way you do math?*
 - *Who/what has influenced the way you feel about math?*
 - *What are three values that are important to you? How can those values help you in math class?*
 - *Describe a positive memory you have about something that happened in a math class.*
 - *Describe a negative memory about something that happened in a math class.*
 - *What makes math challenging? What can we do to help ourselves when we feel challenged?*
 - *What does it mean to be a good math student?*

Prompts to Encourage Student Analysis

- After we have different students/groups present their thinking on the board, we can ask each member of class to write a description of the method that appeals to them most to explain what they appreciate about the strategy/method.
- When we have a class discussion/debate where students try to convince each other of something, instead of us acting as the judge, we can ask our students to write about their opinion, citing what evidence offered by their classmates convinced them.
- We can give them a problem, but instead of asking them to solve it, we can ask them to write out the steps they would take to solve it.
- We can ask our student to present an argument with evidence—for example: If the price of a jacket is raised 50% and then lowered 50%, is the final price the same as the original price? Prove your answer.
- We can give students a mathematical statement and ask them to write a response to it—for example:

“In 1985, 32% of Nigerians were living on less than \$1 a day. In 2007, 71% of Nigerians were living on less than \$1 a day. Between 1974 and 2007, \$728,500,000,000 in oil revenues flowed into Nigeria.”

or

“In 2013, in the United States, more than 45 million people were living below the poverty line. In 2013, the population of the state of California was 38.4 million people. One in five children in the United States lives below the poverty line.”

Don't Check Your Math at the Classroom Door

Ask students to write about a time they used math in the past week (outside of class). This will give you rich material for designing problems and developing lessons using the math in students' lives. It opens students' minds to have them looking for math outside of class. It also helps break down the false wall many students have put up between classroom math and life math.

How the Math Section Works

The Mathematics section consists of four parts: *Curriculum Map*, *9 content-based Units*, a model for *Teacher Reflection* and a list of *Resources*.

THE CURRICULUM MAP

The *Curriculum Map* provides an overview of the mathematical content explored in the units. The map lists the skills and concepts developed within each unit. You will notice that many of the skills and concepts appear in more than one unit. The map allows you to see all the units in which a particular concept is taught—introduced, returned to and expanded. You can also see the content spiraling through the units. Finally, the map also illustrates the overlap between the units, demonstrating how we begin new topics by building off of what has come before.

THE 9 UNITS

- **Introducing Functions** (lesson)
- **Three Views of A Function** (teacher support)
- **Rate of Change/Starting Amount** (lesson)
- **Systems of Equations: Making and Justifying Choices** (teacher support)
- **Nonlinear Functions** (teacher support)
- **Exponential Growth and Decay** (teacher support)
- **Equality** (teacher support)
- **Developing Algebraic Reasoning through Visual Patterns**
 - **Introduction to Visual Patterns** (lesson)
 - **An Open Approach to Visual Patterns** (lesson)
- **Using Area Models to Understand Polynomials** (lesson)

The 9 units are made up of **5 model Lessons** and **5 Teacher Supports**. (If that math seems a little off, it is because there are two full lessons in Unit 8).

Each Unit is centered around either a Lesson or Teacher Support. The 5 Lessons are full-descriptions of activities, from launch to reflection, with step-by-step teacher notes, student handouts and samples of student work. The 5 Teacher Supports are each organized around a core problem and contain a list of skills, key vocabulary, an overview of the problem,

and suggestions for how to teach and process the problem. We also suggest supplemental problems which expand on the core problems and explore other important content within the unit.

The first six units are focused on functions and are meant to be implemented sequentially.

Teachers have more flexibility when it comes to when and how they implement the final three units.

- **Unit 7** focuses on a core concept of algebra that is often challenging for adult education math students—equality.
- **Unit 8** is designed to introduce teachers to the power of developing student algebraic reasoning through visual patterns. The unit features two full model lessons, a sample progression of visual patterns that teachers can work with using the model of either lesson and additional resources. The unit also lists other areas of algebra that can be explored through visual patterns and invites teachers to create their own lessons, targeting those topics using visual patterns.
- **Unit 9** is a progression teachers can implement over a series of classes. The progression starts with the idea of multiplication as repeated addition and develops a coherent thread through area to multiplication with polynomials. It is a model of coherence in instruction, where students not only gain the ability to multiply polynomials, but also understand how it connects to the multiplication of integers they have been doing for years.

Works Cited:

- Daro, P. (2015). Formative Principles of the Common Core State Standards (video). <http://serpmedia.org/daro-talks/>
- Bransford, J. D., Brown, A. L., & Cocking, R. R. (2004). *How People Learn: Brain, Mind, Experience, and School*.
- Hiebert, J. (1997). *Making Sense: Teaching and Learning Mathematics with Understanding*. Portsmouth, NH: Hienemann.
- Lambdin, D. (2003). *Benefits of Teaching through Problem Solving*. In F. Lester (Ed.), *Teaching Mathematics through Problem Solving* (pp. 3–14). Reston, VA: National Council of Teachers of Mathematics.
- Sharma, M. C. (1988). *Levels of Knowing Mathematics*. Math Notebook, v6.
- Swan, M. (2005). *Improving Learning in Mathematics: Challenges and Strategies*. DfES, http://www.ncetm.org.uk/files/224/improving_learning_in_mathematics.pdf.

Math Curriculum Map

This map details the skills and understandings that students will develop through their work across the 9 units. The chart guides teachers to see which skills are explored in each unit. You will notice that many skills are developed over several units and that others come back in later units. This spiraling is designed to support student retention and transference of fundamental content. You will also notice that there is generally an overlap from one unit to the next. This is to reinforce and build off of prior understandings.

DESCRIPTION	UNIT 1	UNIT 2	UNIT 3	UNIT 4	UNIT 5	UNIT 6	UNIT 7	UNIT 8*	UNIT 9
Understanding that for each input in a function, there can be only one output.	■								
Using a one or two-operation rule to complete an In/Out function table.	■	■	■	■	■				
Given a rule, determining an output from an input and vice versa.	■		■		■	■			
Identifying a one-operation rule that fits a given table of In/Out values	■		■						
Identifying a two-operation rule that fits a given table of In/Out values	■	■	■	■				■	
Understanding that a function rule must fit all the In/Out values in the table for that function	■		■	■					
Creating function rules in abstract context and using them to complete an In/Out function table.	■		■						
Creating, reading, and interpreting tables		■				■			
Creating tables from one- and two-operation rules		■	■						
Plotting points in a one-quadrant graph		■	■	■		■			
Relating tables to linear graphs		■	■		■				
Relating tables to nonlinear graphs					■	■			
Drawing inferences and conclusions based on graphed data		■	■	■	■				
Interpreting points on a graph in real-world contexts		■	■	■	■				
Using graphs to fill out tables and create function rules		■							
Testing whether an ordered pair fits a function, using the rule or the graph		■	■						
Discovering the relationship between rate of change, starting amount, and function rules.			■						

DESCRIPTION	UNIT 1	UNIT 2	UNIT 3	UNIT 4	UNIT 5	UNIT 6	UNIT 7	UNIT 8*	UNIT 9
Using rate of change and starting amount to determine function rules from tables.									
Determining rate of change, starting amount, and function rules for contextualized problems.									
Working with fractional rates of change									
Creating function rules that describe real-world situations or visual patterns									
Writing systems of equations in two variables									
Using tables and graphs to compare two linear functions									
Understanding the significance of the point on the graph where two lines intersect									
Using tables, graphs, and guess & check to find solutions to systems of linear functions									
Seeing applications of systems of equations in science and social studies contexts									
Using systems of equations to make and justify choices									
Interpreting systems of equations as a means of negotiation between competing interests									
Interpreting variables in function rules describing real-world contexts									
Translating to formal function notation									
Interpreting function rules that describe real-world situations									
Using charts, tables, drawings and graphs to analyze nonlinear change									
Graphing quadratic functions and relating them to function tables									
Generating outputs from a rule written in function notation									
Understanding constraints on the domain (possible inputs) of a function given a particular context									
Seeing and recognizing the difference between the graphs of quadratic and cubic functions									
Applying quadratic function rules in specific problem-solving contexts									
Using tables, charts, and drawings to model exponential growth and decay									
Seeing exponential growth/decay models in word problems									
Distinguishing between situations that can be modeled with linear and exponential functions									

DESCRIPTION	UNIT 1	UNIT 2	UNIT 3	UNIT 4	UNIT 5	UNIT 6	UNIT 7	UNIT 8*	UNIT 9
Observing that a quantity increasing exponentially will eventually exceed a quantity increasing linearly or as a polynomial function									
Noticing that, in exponential functions, the variable is in the exponent position, and interpreting equations accordingly									
Developing fluency with the different properties of equality									
Creating equations with two or more variables to represent relationships between quantities									
Identifying patterns and observing change									
Using patterns to make predictions and generalizations									
Collecting data in a table									
Developing strategies to move from concrete to abstract models									
Finding recursive and explicit rules									
Creating a written description to define a linear function relationship									
Understanding the use of a variable in the context of a function with two unknowns, (as opposed to solving for a specific value of the variable)									
Solving one-variable equations with one or two-operations (finding the input when given the output of a known function rule)									
Connecting pattern exploration and algebra									
Understanding multiplication as repeated addition									
Develop a better sense of numbers, especially to compose, decompose and factor integers									
Understand the connection between the multiplication of integers and the multiplication of polynomials									
Understanding and using the commutative and distributive properties of multiplication									
Calculating area and perimeter of rectangles									
Multiplying two-digit numbers									
Multiplying binomials and trinomials (polynomials)									
Understanding that two binomials are factors of a single trinomial									
Combining like terms									

* The student objectives for the lessons in **Unit 8: Algebraic Reasoning through Visual Patterns** are included in the chart above. The introduction to Unit 8 also describes a wide range of other math content you can teach through visual patterns, seen below. Using visual patterns to draw out the content below holds further potential for reinforcement and deepening the concepts listed above.

- organizing data (tables and graphs)
- creating/constructing expressions
- creating/constructing equations
- understanding multiple uses of variables and constants
- linear equations (like the arch problem)
- matching function equation to a situation
- connecting parts of equations to concrete pictures
- rate of change/slope
- starting amount/ y -intercept
- graphing (coordinate plane, ordered pairs)
- equivalent functions/expressions
- combining like terms
- evaluating functions
- identifying graph of function (linear and quadratic)
- simplifying expressions
- input/output tables
- independent/dependent variables
- coefficients
- the difference between an expression and an equation
- quadratic equations
- comparing linear, quadratic, cubic functions
- second differences in quadratic functions
- algebraic notation/function notation
- polynomials
- solving for a specific value of a variable
- order of operations
- skip counting
- area and perimeter
- exponents
- perfect squares

Elements of the Overview as well as Units 1, 2, and 3 draw on and adapt pieces of curricula written by Steve Hinds, especially his lesson set titled, Functions Rule.

Lesson Plan

OBJECTIVES

- ✓ Students will understand that for each input there can be only one output.
- ✓ Students will use a one-operation rule to complete an In/Out function table.
- ✓ Students will use a two-operation rule to complete an In/Out function table.
- ✓ Students will identify a one-operation rule that fits a given table of In/Out values.
- ✓ Students will identify a two-operation rule that fits a given table of In/Out values.
- ✓ Students will understand that a function rule must fit all the In/Out values in the table for that function.
- ✓ Students will create their own function rules and use it to fill out an In/Out function table.

ACTIVITY 1 Launch: Math in Love

NOTE TO TEACHER

This first activity gives students experience in working from a rule with inputs to create a table of data. Students will use *Maxine's Rules for Love* to figure out appropriate ages to date. Their own ages will be used as inputs in order to determine the outputs of acceptable ages of dating partners. At the beginning, these skills (and vocabulary) are approached in an implicit way, but they will be made explicit by the end of the lesson.

MATERIALS: *Maxine's Rules for Love* handout

STEPS:

- 1 Give students a few minutes to discuss the following question in pairs:
In your experience, does age matter when people are dating?
- 2 Give students a few minutes to share their opinions with the class. Ask if anyone has (or had) a rule about the youngest or oldest person they are (or were) willing to date.

We begin our lesson with a launch to engage student interest and to draw out some work that can serve as a reference to build off of as we explore a content area. Students tend to see mathematics as disjointed set of procedures to be memorized. We see that as an obstacle to their learning and so we strive to connect mathematical ideas to work they have already done.

In some cases that means connecting to work with previous content. In other cases that means having them do some work and then adding structure and vocabulary. This lesson models the latter.

- 3 Tell them your friend Maxine has a very specific rule when it comes to the age of people she would be willing to date.
- 4 Give students the handout and have them work in pairs to answer the questions. Walk around for a few minutes and address any questions.
- 5 On the board, draw two tables.

The first should look like this:

Name	Age	Youngest person you should date

The second should look like this:

Name	Age	Oldest person you should date

NOTE TO TEACHER: Make sure to leave some space above the Age columns and the Youngest/Oldest Person columns. Later on in the lesson you'll be adding the words "In" and "Out" above each, respectively.

As students finish the questions on the handout, ask them if they are willing to go up and add their numbers to the charts. If some students don't want to share their age, that is okay, but make sure you look over their work.

- 6 Tell students that *Maxine's Rules for Love* is an example of something called a "function." I like to compare functions to car factories. What goes into car factories? Glass, metal, tires, rubber, seats, carburetors, etc. Something happens to all those parts and materials in the factory. And then something comes out—cars. Functions work the same way, but with numbers. You have one number that goes in, something happens to it, and another number comes out.
- 7 Add the word "In" on top of the column for students' ages. Add the word "Out" on top of the column for the ages of the youngest/oldest person they should date. For *Maxine's Rules for Love*: One number goes in (your age), you follow Maxine's Rule, and then another number comes out (the age of the youngest or oldest person you should date). You are likely to have two students who are the same age. If that happens, they should both talk and come up with the

When lesson planning, it can be incredibly helpful to actually map out what you want your board to look like in advance. If you have a big enough board, it's nice to be able to move from left to right and leave the board work up through to the end of class. It can help you make connections between activities and help students see how activities fit together and build off each other.

same youngest/oldest ages. Make sure to draw students' attention to this. If it doesn't, ask what they would expect to happen if two students of the same age used Maxine's rule. You want them to realize something along the lines of, *If the same number goes in and we do the same thing to it, the same number will come out.*

Once everyone feels good about the rationale, write the following sentence of the board and have them copy it into their notes:

When we are working with a function, each input can only have one output. This is a rule that should be referenced in future classes.

- 8 Ask students what they think about Maxine's Rule. Do they think it's reasonable? When does it make sense? When does it not make sense?
- 9 Tell students we are now going to explore the idea of functions in a game called, "My Teacher is a Computer."

ACTIVITY 2 My Teacher is a Computer

MATERIALS: Board/Newsprint and marker

STEPS:

- 1 The way the game works is as follows: Students give you a number, you do something to that number in your head, and then you tell students what number comes out. They are going to keep giving you numbers to put into your computer and try to guess what is going on inside the computer, i.e. what you are doing to the numbers in your head. It is important to make clear that students should not call out the rule. When they think they have figured out the rule, they should raise their hand and say so without revealing what they think the rule is.
- 2 Tell students that you are going to help them keep track of their guesses in a table on the board or newsprint. Write **In** over the top of the left column and explain that is where the numbers they give you will be recorded. When write **Out** over the right column and explain that is where you'll record the numbers that come out of your "computer."
- 3 Next, give students a limit (maximum and minimum) for their guesses. This step isn't absolutely necessary, but might be a good idea to keep things simple at first. I usually ask students to keep their numbers between 0 and 20. Another option is to use the range to introduce some algebraic notation. You might write $0 \leq \text{In} \leq 20$ and see if anyone knows what it means. If someone does, great, but chances are, very few of your students will be able to say, "The input has to be greater than or equal to 0 and less than or equal to 20."

As with all important points you want to emphasize in class, don't assume that because one student understands that everyone else understands too. Ask other students what they think of what was said. Ask them to restate it in their own words. Ask them if it will always be true.

That's fine. Just write it on the board and have them copy both the notation and the statement explaining what it means in their notes. Whatever you decide, don't spend more than a few minutes on this step.

- 4 Repeat the request that students not call out the rule once they think they have figured it out. Use “add 9” as your first rule. Obviously, don't tell students your rule. Instead, ask a student to give you a number. Put that number in the “computer” and record the number as an entry in *In* column. I like to give my students a visual and actually act out the number going in by gesturing as if I am actually putting the number into my head with my right hand (so students will see it going in on the left). For the calculation part I use both hands to mimic washing my hair. Finally, I gesture with my left hand of a number coming out of my head. Then enter the number that comes out to the *Out* column of the table, next to the corresponding *In* number. Now, ask the class to give you different numbers to put in the computer.
- 5 Once a student says they have figured out the rule, remind them not to say it out loud. Instead of giving the rule, the student will get an opportunity to show if their rule matches the computer. Give the student a number to put in (still recording it in the table). Ask her, *If you put this number in, what number would come out?* If she is correct, tell her so and add the output in the table. If they give you a number that is not what should come out, tell them so and record the correct output in the chart—*If you put a ___ in, you will actually get a ___ out.* Either way, keep going until more students have figured out the rule, handling their guesses in the same way.
- 6 Once you have a good number of students who have correctly identified the rule (by giving the correct output), ask one of them to say what it is that is happening inside your “computer” and write it above the table, next to the word, **Rule**. Once the rule is established, tell the class you want to go back and check to make sure that rule works with all of the inputs and outputs. Give them an opportunity to check. Once they are sure the rule works for all of the inputs and outputs, ask a few students to talk you through their process. Encourage them to use the language of functions: *When you put a 14 in and subtract 4, you get a 10 out.*
- 7 I recommend playing this game at least three times on the first day. (The game can be used at different points in a curriculum on functions, since you can use more complex rules as students become comfortable analyzing input/output charts.) I like to use rules that get more and more complicated. Try a few single step rules, and

6

This language helps students internalize a structure of thinking that will help them develop flexibility as they have to adapt to different kinds of function questions.

use different operations. You might try *add 9*, then *subtract 4* and finally *multiply by 3*.

- 8 Finally, play a round with a two-step rule. Try something simple, but not too easy—like *multiply by 4, plus 2*. Follow the directions for the game in steps 1 to 6, but I would recommend telling students in the beginning that the rule they are looking for is a two-step rule. It is not necessary, but if you don't, it makes it more challenging and at this point we still want to prioritize students getting a feel for the flow of the input to the rule to the output. Keep in mind that a two-step rule will likely take longer for students to figure out than a single step rule.

After it is all said and done, your board might look something like this:

My Teacher is a Computer

$0 < In < 20$ $0 \leq In \leq 20$

Rule: Multiply the "In" number by 4 and add 2

In	Out	In	Out	In	Out	In	Out
2	11	8	4	14	58	10	42
9	18	9	5	16	66	6	26
15	24	16	12	3	14	8	34
10	19	14	10	17	70	11	46
7	16	20	16	1	6	2	10
3	2	7	3	4	18	5	22
5	14	18	14	0	2	19	78
				7	30	12	50
				20	82		

- 9 Ask, *Were any numbers you put in especially helpful for figuring out the rule? How so?* You can point them back to all of the tables and rules written on the board. There is no need to push to get too much out of students with this question, at this point. What they say will depend on the In numbers that students suggested. But even if their answer is “No,” it is a good question to ask to raise the idea that there might be a strategy in choosing the numbers we put in. Ask them to keep the question in mind. They might say things like “putting a zero in was helpful” or “Choosing consecutive numbers helped.” Though it is too early to make this point now, these are useful connections to concepts like starting amount (y-intercept) and rate of change (slope) in later classes.

ACTIVITY 3 One Rule to Bind Them All**MATERIALS:**

- *One Rule to Bind Them* handout, cut into individual strips, one for each group
- Several sheets of newsprint and several markers (one for each student group)

STEPS:

- 1 Break students into groups of 3 to 4 students. Give each group a piece of newsprint and marker. If newsprint is not available, consider breaking them into smaller groups and have them do the activity on regular paper.
- 2 Explain that for the next activity they are going to be working with functions, but in a different way. You are going to give each group one input and one output—which is to say, “*If this number goes in, something happens to it and that number comes out.*” Ask them to write and label their *In* and their *Out*. Their job is to come up with as many different ways as possible to explain what is the something that might be happening.
- 3 THE ONE RULE TO BIND THEM handout has some sample Input/Output pairs you can use. Cut out each pair and give one to each group. Remember to give only one input and its corresponding output to each group.

There is only one function rule that works with all of the inputs and outputs: “**times 2, then plus 2.**”
- 4 Walk around as they are coming up with all the different ways to get from their input number to their output number. If any groups struggle, give them at least five minutes without any intervention from you (unless they are struggling with understanding the instructions). Here’s a potential series of questions you can ask to help them get unstuck. Ask only enough for them to start working.
 - a. *Is the number getting bigger or smaller?*
 - b. *What operations could you try to make the numbers bigger?*
 - c. *Is there a way to get from the input to the output in one step?*
 - d. *Are there any other ways to do it in one step?*
 - e. *How could we get from the number that went IN to the number that came OUT doing two things?*
 - f. *Pick a number to multiply the IN by. What did you get? How could you get from that number to the OUT?*

- 5 You want each group to have several ways to get from their input to their output. As you walk around, you might encourage some friendly competition and say things like, *Hmmm... this group found 8 different ways to go from their input to their output. And they're still looking for more!*
- 6 You also need every group to have “times 2, then plus 2” in their list of rules. Once that happens, have everyone tape their newsprint next to each other on the wall. Ask each group to share all the different ways they came up with to get from the IN to the OUT. After every group has shared, ask the class what they notice. At least one person will notice is that there is one way that is true for all of the INs and OUTs: “times 2, then plus 2.” Ask the class what they think about that.

Here’s an example of what it might all look like:

The image shows three examples of student work, each with an 'In | Out' table and a list of rules:

- Example 1:** In: 7, Out: 16. Rules include: $\times 3 - 5$, $+ 25 \div 2$, $+ 7 + 2$, $\times 2 + 2$, $\times 1 + 9$, and $+ 9$.
- Example 2:** In: 10, Out: 22. Rules include: $\times 3 - 8$, $+ 10 + 2$, $\times 5 \div 2 - 3$, $\times 4 - 18$, $\div 5 + 11$, $\times 4$, $+ 3$, $+ 8 - 4$, $\times 2 + 2$, $\times 16 - 12$, $\times 10 - 6$, and $\times 5 - 1$.
- Example 3:** In: 3, Out: 8. Rules include: $\times 3 - 1$, $+ 10 - 5$, $+ 9 - 4$, $\times 0 + 8$, $\times 4 - 4$, $+ 5$, $\times 2 + 2$, $\times 1 + 5$, and a note: "Anything Multiplied by zero plus 2" with 15×2 .

- 7 Draw a table with all of the inputs and outputs they’ve been working with.

Point to one of the rules for an input of 1 and an output of 4 other than “times 2, then plus 2.” For example, “times 4.” Ask the class if you should write that rule in the space above the table. Whatever students say, yes or no, ask them to defend their answer and ask other students what they think. You want students to arrive to the conclusion that you can’t put “times 4” in as the function rule because it only works for one of the input/output pairs. A function rule must fit all of the input/output pairs.

In	Out
1	4
3	8
5	12
7	16
10	22

For a final question, ask the class how many input/output pairs they would need to come up with a rule for a function.

Can you do it with one pair? Can you do it with two?

ACTIVITY 4 Function Machines

MATERIALS:

- *Function Machines 1* handout; *Function Machines 2* handout
- Blank *Function Machines* (optional)

STEPS:

- 1 Tell students that they've been looking at a few different kinds of function skills.

For *Maxine's Rule*, they were given a rule and put numbers in to find the numbers that come out. You might go back to the tables on the board for that activity and ask students to add the rules for each (divide by 2, then add 7; subtract 7 then times 2).

For *My Teacher is a Computer* and *One Rule to Bind Them*, they had the inputs and the outputs and they had to come up with the rule.

- 2 Explain they are now going to have an opportunity to practice those skills using something called a "function machine." Explain that a function machine can be a helpful way to think of functions, similar to a car factory and to *My Teacher is a Computer*.

Draw a picture of a function machine and the following table on the board:

In	Out
3	6
5	10
7	14
9	18
11	22
13	26

Explain that function machines are another way to represent and visualize functions. It is similar to the other models we've

2

When we know there is a common mistake that students might make—such as not checking a rule against several input/output pairs—it can be really nice for teachers to “make” the mistake themselves. It raises the issue but it puts the responsibility to correct it onto your students. It is always better if they are the ones who say, “Add 3 only works for the first input and output. A function rule has to work for all of the inputs and outputs.”

looked at. A number from the left column of the table goes in (at the top of the machine), something happens to that number in the middle of the machine and then a number comes out of the bottom of the machine.

Ask students what the rule is. You'll get a range of answers, and if they are correct, they will be equivalent—"times 2," "double," "the in plus itself." Add them all to the box and give students a chance to decide if they are different rules or if they are all the same. If a student does not suggest it, ask if the rule could be "add 3." When students say no, ask them why not. Even if they say the rule can not be "add 3," push back a little with, "But if you put a 3 in and add 3, you will get a 6 to come out."

- 3 Give out FUNCTION MACHINE 1 handouts and tell students that each machine will give them different pieces of information about each function—their job is to use that information to figure out what's missing. Some of the machines will give inputs and outputs but the rule will be missing. Some machines will give a rule and students will have to find the inputs and outputs. The bottom line is, whatever is missing, they should try to find it.

Walk around and look at student work. Unless they ask you a question, try to spend at least five minutes just watching what they are doing. Be on the lookout for challenges, struggles, interesting strategies and common mistakes. These will give shape to the whole-class discussion.

One thing that you will definitely want to talk about in the whole-class discussion is what students do when they are given a rule and an output and asked to find the input. For example, look at the machine on the top right on page 1 of the FUNCTION MACHINES 1 handout. Students first have to figure out that the rule is "subtract 4." Once they do, they put the 20 in and get a 16 out.

What many students do next is put the 50 in (even though it is in the *Out* column) and write 46 in the *In* column. This is a great and important mistake for students to make and you should not address it beforehand or intercede if you see a student making the mistake.

Rather than just correcting them, you want to model a process they could use in the future to (a) catch a similar mistake and (b) correct themselves. Instead of stepping in, walk around and get a sense of which students are making the mistake. After a little while, start asking students to talk you through one of the machines. I'm going to give you a sense of how the conversation might go for the function machine on the top right, but you can use it as a guide to discuss any of the machines where the output is given and students

3

You may have some students who use the inverse operation and work the rule backwards to go from the output to the input. You may be tempted to teach your students how to do that yourself. I would strongly encourage you to hold off at this point in your class' work with functions. If a student happens to be able to do it on their own and is consistent and understands why it works, great. But for many students it can be confusing and our goal for this first lesson is to get students comfortable with one function rule and its relationship with its function table.

have to determine the input. Rather than asking them about the 46 right away, have them talk you through the whole machine. Ask how they know the rule is “subtract 4.” Encourage them to use the language of the function machine: *If you put a 6 in and subtract 4, a 2 will come out. If you put an 8 in and subtract 4, a 4 will come out....*

Once they get to the 46, listen to what they say. Some students may catch the mistake in their own throats when they say, “If you put a 46 in and subtract 4... wait.” Some students may switch columns and say, “If you put a 50 in, and subtract 4, a 46 will come out.”

If that happens, use the visual of the machine and columns to ask whether one of the earlier outputs is an input or an output.

You want to help students see that when they are given a rule and an output the question changes and becomes, *What number has to go in, to follow that rule and give us this output?* Another question to help students to see this to ask, *What is the difference between the 20 and the 50?*

Once they understand they are looking for the number that goes in, encourage them to use guess and check as an effective strategy. The questions *What could it be?* or *What if it was ___?* are good questions for students as general problem-solving strategies and they can be really helpful here. Students try a number, use the rule and see if they get the given output. If not, are they too high or too low? Should the next number they try be larger or smaller? How can we use the other inputs and outputs to make our guesses?

4

Function Machines 2 introduces rules that involve decimal multiplication. It can help students think of the decimals in terms of money and the multiplication in terms of groups. Students may not remember the rules for multiplying decimals. Another approach is to think of 3×1.50 as “three groups of 1.50.” Seen this way, many student will be able to do the calculations in their heads.

- 4 Give out FUNCTION MACHINES 2 handout. Function machines are a great way to introduce/review/explore different content areas. Once students have an understanding of how they work, you can use them to focus on topics you are working on in class. For example, you will see FUNCTION MACHINES 2 has multiplication with decimals, percent change and offers an opportunity to talk about square roots and exponents.
- 5 In addition to the two function machine handouts, you will find two pages of blank function machines. Use these blank machines to create your own rules over the course of a semester—it is a good way to continue student exposure to the core concepts of functions as well as incorporate other mathematical topics.
- 6 For students who want to practice function machines on their own, I recommend the following Internet resource:
<http://www.mathplayground.com/functionmachine.html>

ACTIVITY 5 The Function Game

MATERIALS: *Function Game* handouts

STEPS:

- 1 Tell students that they have been doing a great job working on all the different functions you've thrown at them and now it is their turn. They are going to have an opportunity to create their own function rules and tables. Ask them to write a one-operation rule and a two-operation rule on a piece of paper. Tell them you are going to try to figure out their rule and that they can try to make it as difficult as they like.
- 2 Give out the FUNCTION GAME handouts. Ask students to use each of the rules they came up with to fill out each of the In/Out function tables. Make sure they do not write the rule on the handout! It will be good practice for them to actually do the calculations themselves, so for this activity I would encourage teachers to ask students not to use calculators. Teachers can give out multiplication tables as support.
- 3 Have students write their names on the handouts and collect them. I always try to work on them, figure out all the rules, and give it back to students by the next class
- 4 *The Function Game* is a great activity that works as an in-class assignment or as a homefun assignment. It serves as a good assessment that provides some insight into what students are retaining from today's function activities.

3

I like to pick out a few favorites before the next class and ask those students if they would be willing to have the class guess their rule using the structure of "My Teacher is a Computer" but changing it to "My Classmate is a Computer."

NOTE TO TEACHER

As you are working through your students' rules, look for ones that don't work. Spend some time and analyze why they don't work and ask yourself whether it is a good mistake for other students to consider. For example, I once had a student whose table looked like this (*see right*).

I started off our next class having the students who had written some of my favorite rules play the *My Classmate is a Computer* game with the class. Then I said I wanted to share *My Favorite No*, which I explained as a really interesting mistake that I thought everyone could learn from. I wrote the table on the board and asked everyone to spend a minute just thinking about what this mistake could teach us. After a few minutes, students shared some of their ideas. One thing I definitely wanted to see if anyone would say is that this does not fit with what we learned

In	Out
5	5
5	10
5	15
5	20
5	25
5	30

about functions because you have different outputs for the same input. Someone else said something that the class liked when our conversation shifted to where the mistake came from and how we could all be careful to avoid it in the future. She said, “I think the rule is ‘times 5’ and they meant ‘1 times 5’, ‘2 times 5’, etc. but maybe in their head they were saying ‘5 times 1’, ‘5 times 2’, ‘5 times 3’, etc., and so they got confused with the 5 and the *In* because they were doing the 5 first.”



Check-Out/Exit Ticket

- Ask students to look at the board to remember all the activities they’ve done (*Maxine’s Rules for Love*, *My Teacher is a Computer*, *One Rule to Bind Them* and the function machines.) Tell them that they are going to write for a few minutes about what they want to remember about today’s lesson.
- On a separate piece of paper—you’ll be collecting it—have students answer the following two questions:
 - What do you know about functions?
 - What is one question you have about functions?

They will say different things and all are okay. Give them a couple of minutes to think about the question and share their answers, either in pairs or in a whole-class reflection. You may hear things like:

- “There are lots of different ways to get from an input to an output but there is only one that works for all of them.”
 - “What I understand is the rule has to be used with each in number to equal the out number to make it a pattern.”
 - “If you are looking for different ways to get from an input to an output, it is easy to start with the one-operation possibilities first.”
 - “When you are trying to figure out a rule, don’t cross out any of your guesses.”
- Collect all of the responses as an assessment to make sure you hear all voices and get a sense of what impressions students are leaving the room with in terms of functions. Look for any common misconceptions and misconceptions of individual students. Look for some well-phrased reflections that you can bring back and share with the class.

Maxine's Rules for Love

Maxine has a mathematical rule that she uses when it comes to love. Maxine says that, in her opinion, when it comes to the age difference between two people in a romantic relationship, the younger person should never be younger than half the older person's age plus seven more years.

1 Following Maxine's rule, would a couple made up of a 44 year old and a 27 year old work? Explain your answer.

2 According to Maxine's rule, what is the age of the youngest person you should date?

Maxine has a slightly different rule for figuring out the age of the oldest person she is willing to date. She says to find out the oldest person you should date, take away 7 years from your current age and then double that number.

3 According to Maxine's rule, what is the age of the oldest person you should date?

One Rule to Bind Them

Teacher Instructions:

 Cut out each In/Out pair. Give one to each group.

In	Out
7	16

In	Out
3	8

In	Out
1	4

In	Out
10	22

In	Out
5	12

Function Machines 1

In	Out
2	4
3	6
5	10
10	20
20	40
100	200

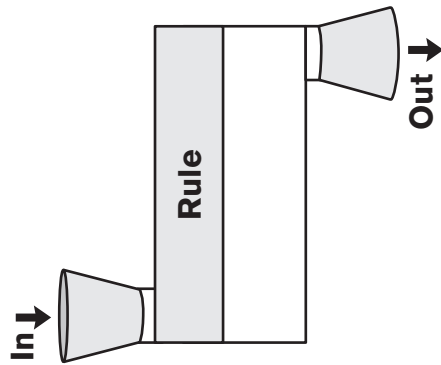

In	Out
6	2
8	4
10	6
14	10
20	

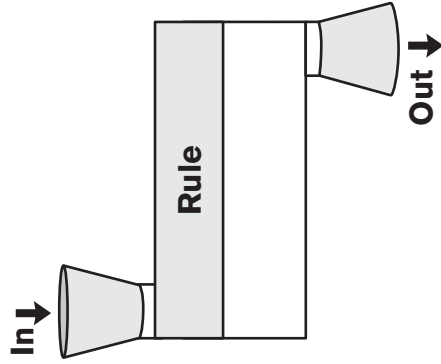

In	Out
1	6
15	20
4	9
30	
22	
	58

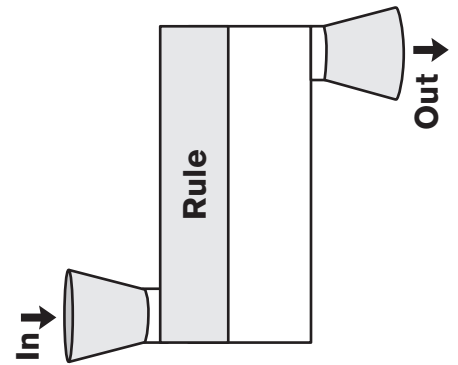

In	Out
10	5
14	7
24	12
	6
	20
	300

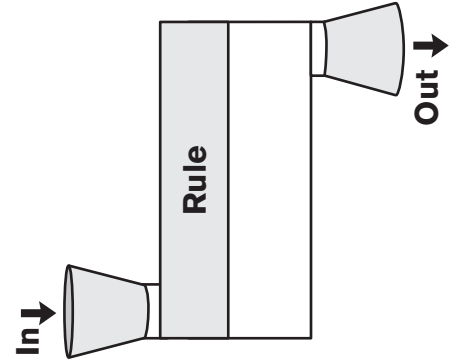

Function Machines 1

In	Out
2	8
3	
5	
10	20
	100

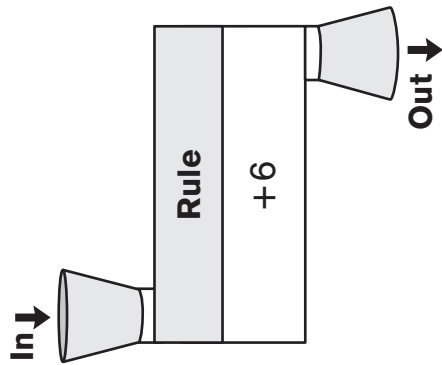

In	Out
60	45
80	
15	
115	115
	26

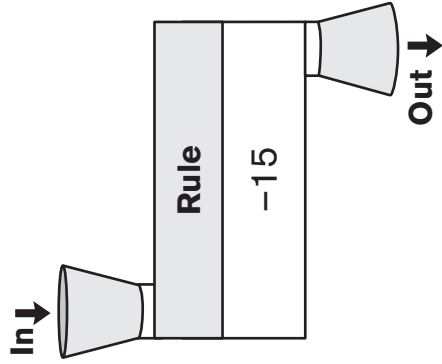

In	Out
.50	
.65	
1	
1.2	5
	6.25

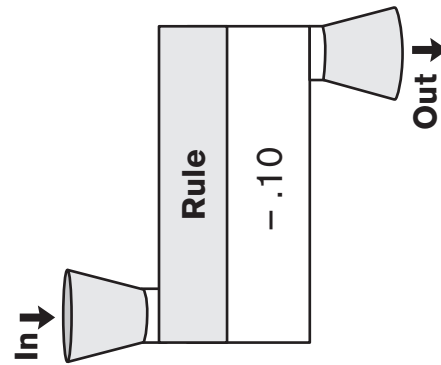

In	Out
6	8.25
1.50	3.75
5	
10.75	21.25
	30

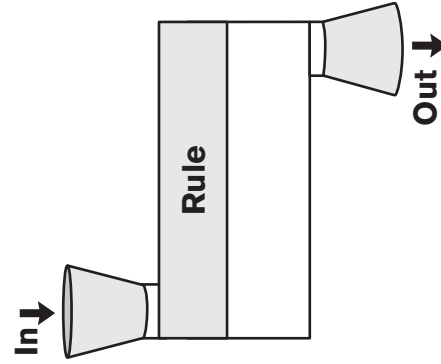

Function Machines 2

In	Out
16	8
10	2
20	
	100
	0
	95

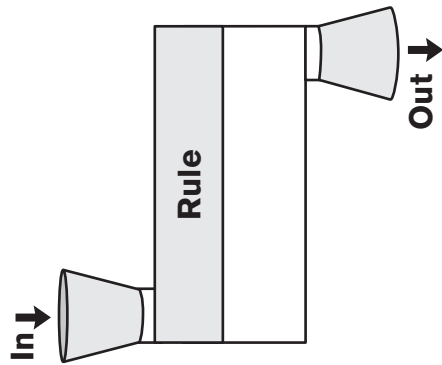

In	Out
10	
16	
20	
	6
	75
	36

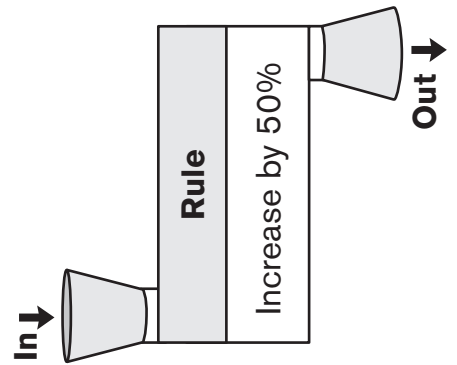

In	Out
10	40
2	8
6	
	60
	36
	320

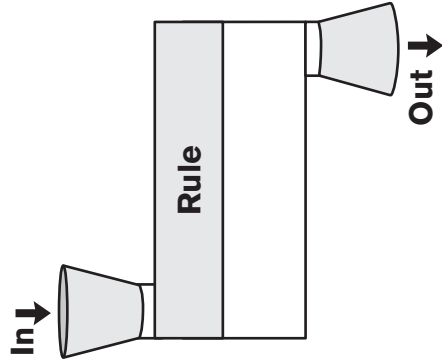

In	Out
4	
12	
16	
	24
	50
	100

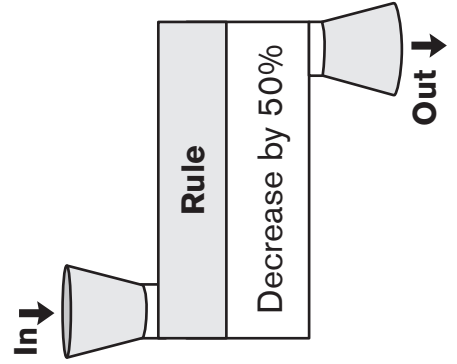

Function Machines 2

In	Out
1	
4	
12	15
	2.6
	170

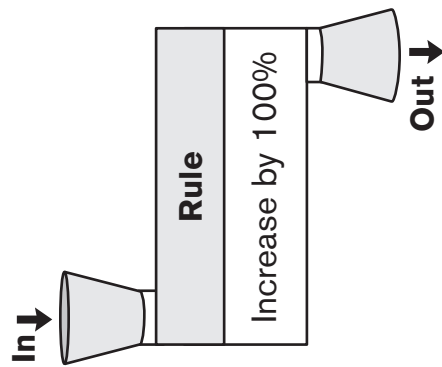

In	Out
1	
2	
5	36
	64
	289

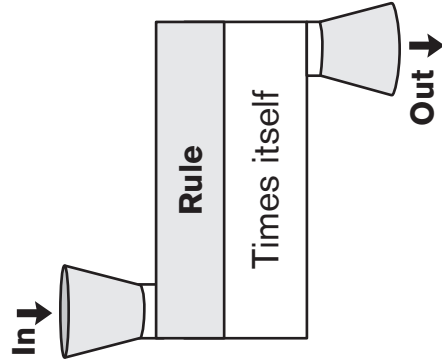

In	Out
1	
2	
3	
10	7.50
	16.50

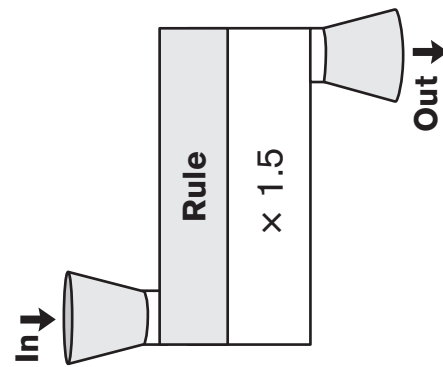

In	Out
1	
2	
3	
10	
40	18

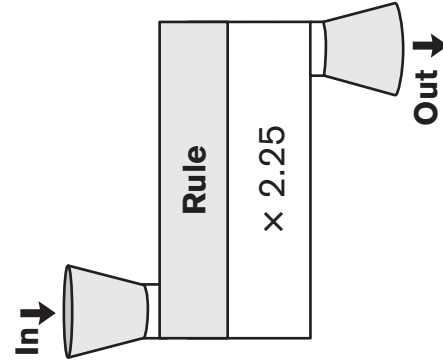

More Function Machines

In	Out

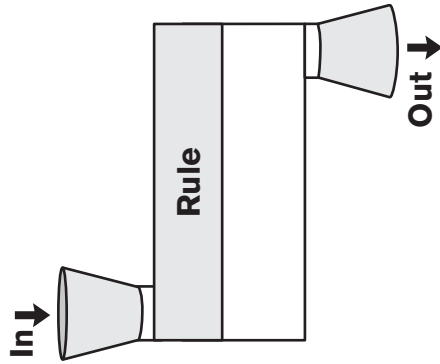

In	Out

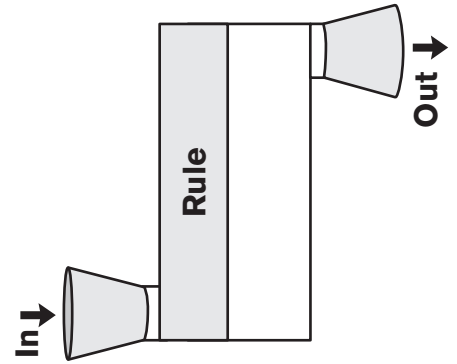

In	Out

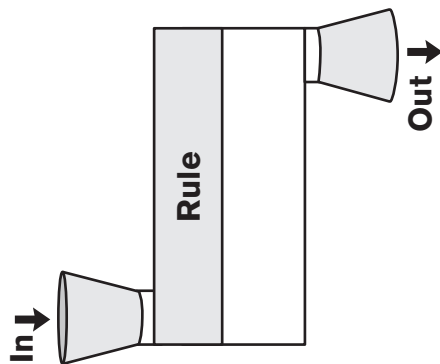

In	Out

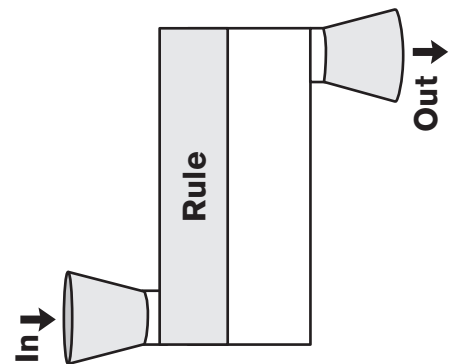

More Function Machines

Fill in missing values and/or rules.

Rule:	
In	Out

Rule:	
In	Out

Rule:	
In	Out

Rule:	
In	Out

The Function Game

Now it is your turn. You are going to create your own function rules!

Write a one-operation rule and a two-operation rule on a separate piece of paper. I am going to figure out your rule and you can try to make it as difficult as you like. Use each rule to fill in the Inputs and Outputs for one of the tables below. Do not write your rule on this handout!

Rule:	
In	Out

Rule:	
In	Out

One of our greatest strengths—our practice of starting from where students are and having a serious respect for their learning processes.

The problems in this unit introduce students to the three views of a function: a rule, a table, and a graph. At the heart of the unit is the *Commission Problem*, which uses linear models for income growth to teach the basics of plotting points and graphing linear functions. After completing the problems in this unit, students will be able to draw explicit connections between function rules, tables, and graphs, and they will develop the foundational skills needed to interpret and graph complex functions like those that they will see in future units and on an HSE test.

SKILLS DEVELOPED

- Creating, reading and interpreting tables
- Creating tables from one- and two-step rules
- Plotting points in a one-quadrant graph
- Relating tables to linear graphs
- Drawing inferences and conclusions based on graphed data
- Interpreting points on a graph in real-world contexts
- Testing whether an ordered pair fits a function, using the rule and the graph

KEY VOCABULARY

axis: a fixed reference line used for placing coordinates. The horizontal axis is the x -axis and the vertical axis is the y -axis. The axis of a graph might also be labeled, connecting it to a real-world context.

function solution: a function solution is an *ordered pair*—an input and an output—that fits a function rule. Put another way, solutions—also called coordinates—are written as ordered pairs of the form (x, y) , where x determines the position along the horizontal axis, and y determines the position along the y -axis. They are a set of values used to show an exact position. (*coordinates*)

linear: a relationship in which a graphed set of function solutions form a straight line.

plane: a two-dimensional surface.

ratio: a comparison of two quantities, often written as a fraction. In this unit and subsequent units, the slope of a line is the ratio of its vertical change (rise) to its horizontal change (run).

Core Problem Overview: The Commission Problem

The *Commission Problem* creates a situation in which a married couple—Eric and Nancy—sell fish tanks for competing companies. Eric is paid a monthly salary of \$1400 and a commission of \$75 for each fish tank that he sells. Nancy is not paid a monthly salary, but her commission is much higher; she earns \$250 per fish tank. In working on the *Commission Problem*, students will first make a choice about whose job is better based on the numbers.

After students have had time to share their initial thoughts, they will work to find how many fish tanks each person would need to sell in a given month so that they both earn the same amount of money. Students should be given time to struggle with the problem, and you should support any method that the student has chosen. However, you should try to help struggling students organize their information into a table. The sample of work below shows a table used by a student to solve the problem. Not all students will create a table like this one, but during the processing part of the activity, you want to make sure that any students with tables that resemble input/output tables go to the board and to share their work with the group. You really want the table to come out. If no students use this method, the teacher should share it, but only after students have presented and commented on their own strategies. In the end, all students should understand that Eric and Nancy will make the same amount of money in a month when they both sell eight fish tanks.

Nancy		Eric	
Tank	Earnings	Tank	Earnings
0	0	0	0
1	250	1	75-1475
2	500	2	150-1550
3	750	3	225-1625
4	1000	4	300-1700
5	1250	5	375-1775
6	1500	6	450-1850
7	1750	7	525-1925
8	2000	8	600-2000

That is the point that will stand out to students on the graph. That said, there is more than one answer to this problem the way it is phrased. Eight fish tanks is the number of tanks Eric and Nancy need to sell to earn the same amount of money and sell the same number of fish tanks. There are other ways for them to earn the same amount. For example, if Eric sells 18 tanks and Nancy sells 11, they would both earn \$2750. If Eric sells 28 tanks and Nancy sells 14, they would both earn \$3500. Teachers can use this fact as an extension problem for students and ask, *Are there any other ways for them to earn the same amount of money?*

For the last part of the activity, distribute the graph showing Eric’s income alongside Nancy’s income. Notice that the graph does not indicate which line represents Eric and which represents Nancy. The goal is for students to figure this out on their own, with some support from you. You should first give students five minutes to look at the graph on their own, and then lead a whole-class discussion about the information represented in the graph. By the end of the activity, students should be able to identify which line represents each person, and they should also be able to extract information from the graph, such as how much money the couple would make if they each sold twelve fish tanks. You also want to have students spend some time talking about the significance of the point where the two lines intersect. Depending on the level of the class, you might choose to ask students to create a function rule for Eric and Nancy. If students are not ready to do so at this point, you can return to the tables and graph for the Commission Problem after Unit 3: Rate of Change.

TEACHING THE CORE PROBLEM

During the first part of the activity, in which students decide who has a better job, you should help students to understand the problem by asking clarifying questions. Some examples are:

- *Tell me about what this problem is asking. Can you put it into your own words?*
- *How much would Nancy make if she didn’t sell any fish tanks? How much would Eric make?*
- *I see you think that Eric/Nancy has the better job. Can you tell me how you decided that?*

Once all students have made a decision and justified it in writing, ask the class to vote on who has a better deal, and write the tally on the board. Students who say that Eric does may point out that he will still make money in a month when he isn’t able to sell any fish tanks, whereas Nancy would make nothing. They may also note that Nancy will always have to work a little bit harder, since her income is solely dependent on the number of fish tanks that she sells. Students who say that Nancy has a better job might say that she has the potential of making more money in a month than Eric since she makes more in commission per fish tank. At this point in the activity, do not tell students that their choice is right or wrong; instead he or she should allow time for the students to justify their choices and talk to one another about the problem. You might hold a few different votes and see if any of the arguments reverse an opinion or two. If they do, ask the

student who changed their vote to explain what they found compelling about the argument that swayed them.

Then direct students to the question on the second page. Students should be given ample time to work individually before they discuss their findings with classmates. While the students are working, continue to support their individual problem-solving efforts through questioning. Some students will use guess-and-check to get started on the problem, and you should support this method as much as possible. If students get frustrated while trying this approach, ask if there is a way to organize all of these guesses. Ideally, this will result in students creating a table of some kind. As students are working, the teacher should check in with each student and ask them to explain their thinking, how they got started, and what aspects of the problem they are struggling with. Some students will forget to figure Eric's salary into his income. You will need to help these students get back on track without giving too much away.

PROCESSING THE PROBLEM

After all students have solved the problem through guess and check, creating a table, or a combination of these methods, the teacher should lead the class in a discussion of solution strategies. The teacher should select three or four students to talk about their work and show it on the board or on chart paper. During the presentation of solution strategies, ask questions that help the class process the solution method being demonstrated:

- *What do you like about this method?*
- *How do we know that this answer is correct?*
- *Have we seen a table like this before? Where?*
- *How do the tables connect to the function machines from the previous unit?*
- *Does this change your opinion of who has a better deal? Why?*

Now that the class has talked about solution strategies, distribute the graph of Eric and Nancy's salaries. Ask the class to silently study the graph for a few minutes on their own. After looking at the graph for a few minutes, at least one of the students should notice that the numbers match those that they were working with in solving the problem. Some questions to help students process the graph are:

- *Which line represents Eric? Which represents Nancy? How do you know?*

- *Why does Eric’s line start higher than Nancy’s line?*
- *Who would make more in a month when both Eric and Nancy sold four fish tanks? How much more?*
- *How much would Eric make if he sold twelve fish tanks? How much would Nancy make?*
- *Which line is changing faster? Does that make sense given the information in the problem?*
- *What do you notice about the difference in their earnings if they each sell 16 fish tanks?*

Take this opportunity to introduce the term *axis* and *coordinate* when talking about specific data points on the graph. Add a third column to the tables from the Commission Problem and have students write in the ordered pairs. Students should then be asked to label the axes “Earnings” or “Income” and “Number of Fish Tanks Sold.”

SUPPLEMENTAL PROBLEMS

The supplemental problems in this unit build upon the core problem by helping students become familiar with plotting points and lines in a one-quadrant graph. Depending on the students’ familiarity with graphing and their struggles during the commission problem, the teacher may choose to use some or all of these problems in the classroom. Some may also be assigned for homework.

■ **The Three Views of a Function**

These problems offer practice for generating a table based on a rule, creating coordinates, and then plotting them in the plane. Students should be guided to connect the dots to form lines, and they should talk about similarities and differences in the graphs that they have created.

■ **Cooking with Functions**

This problem builds upon the Three Views of a Function worksheet by asking students to think about the correct ratio of water to rice when cooking. Some of the data points will form a line representing the correct 2:1 ratio, while others will fall either above or below the line. These are points that do not fit the function rule. Students will be asked to make conclusions about each of the points. For example, one of the points is located at (3, 2). This point falls above the line. By analyzing the graph and the ratio, students should see that there is not enough water, and therefore the rice will be too crunchy, or too dry. It is also interesting to ask students what they notice about the points that are above the line and those that fall below it.

■ The Cab Fare Problem

In this problem, students will need to use data to construct a graph and draw a conclusion about how a taxi company calculates the total fare for a ride. Students are given information from three riders. They will need to plot the points, identify a linear relationship, and draw conclusions about what the fare would be for other travel distances.

*Core Problem***The Commission Problem**

Eric and Nancy are married, and they work part-time as salespeople for two different companies. They both sell fish tanks to high-end restaurants in the New York City metro area. Eric's employer pays him a monthly salary of \$1400, plus a commission of \$75 for every fish tank that he sells. Nancy's employer does not pay her a salary. Instead, they offer her a commission of \$250 for every fish tank that she sells.

Nancy tells Eric that she has a better deal than he does, because she makes more money on each fish tank that she sells. Eric says this isn't true. "I have a better deal," he says, "because I get paid even if I sell zero fish tanks."

Who is right? Why?

The Commission Problem, Part 2

Eric and Nancy want to contribute equally to their finances.

How many fish tanks would they each need to sell so that they bring in the same amount of money?

The Commission Problem

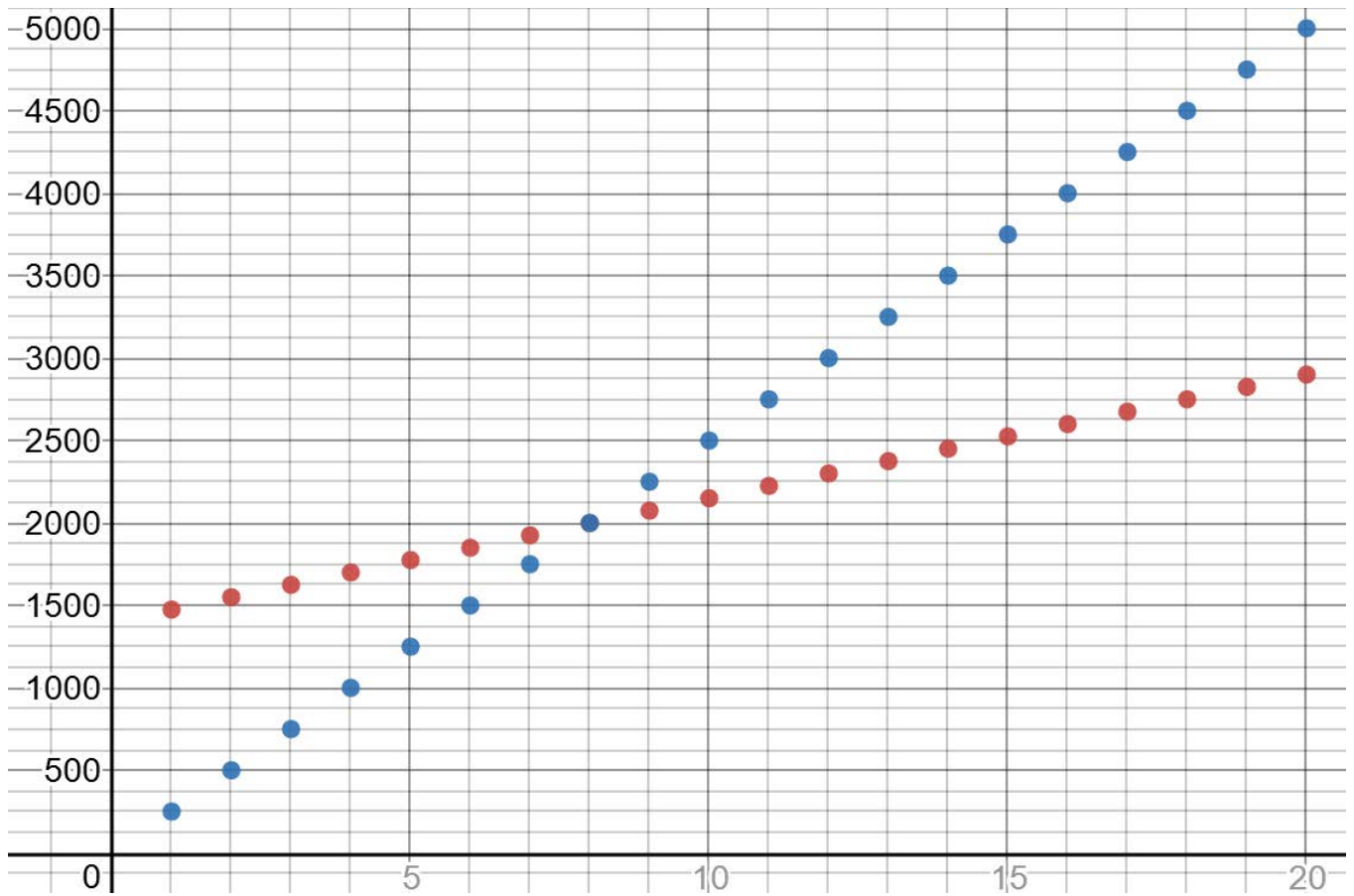

The Three Views of a Function

Rule: +4		
In	Out	Solution
0		
1		
2		
3		
4		
5		
6		
7		

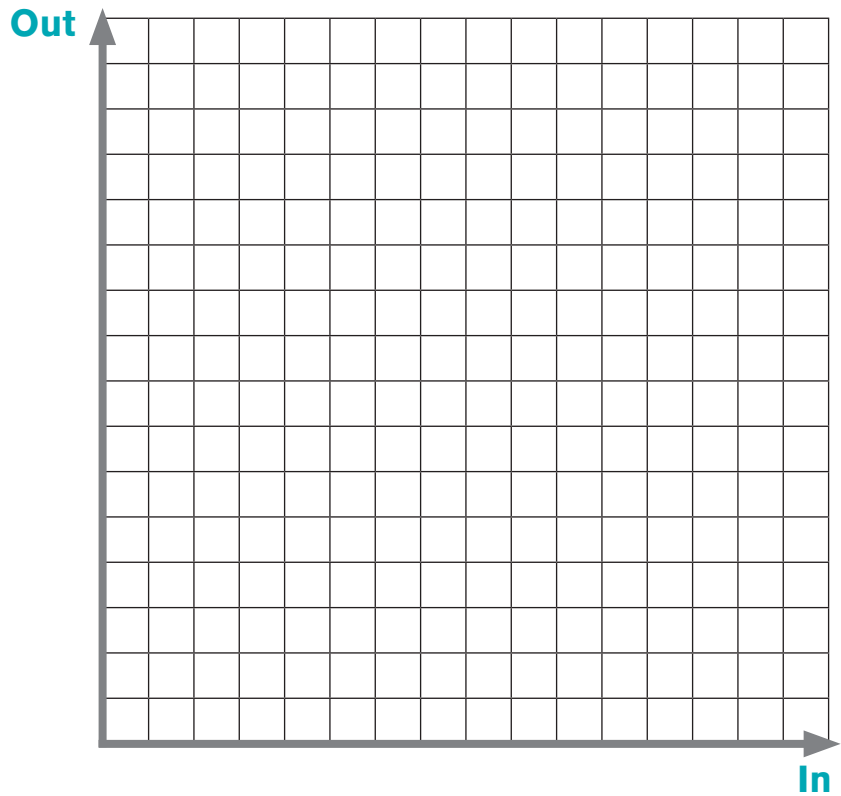

Rule: x2		
In	Out	Solution
0		
1		
2		
3		
4		
5		
6		
7		

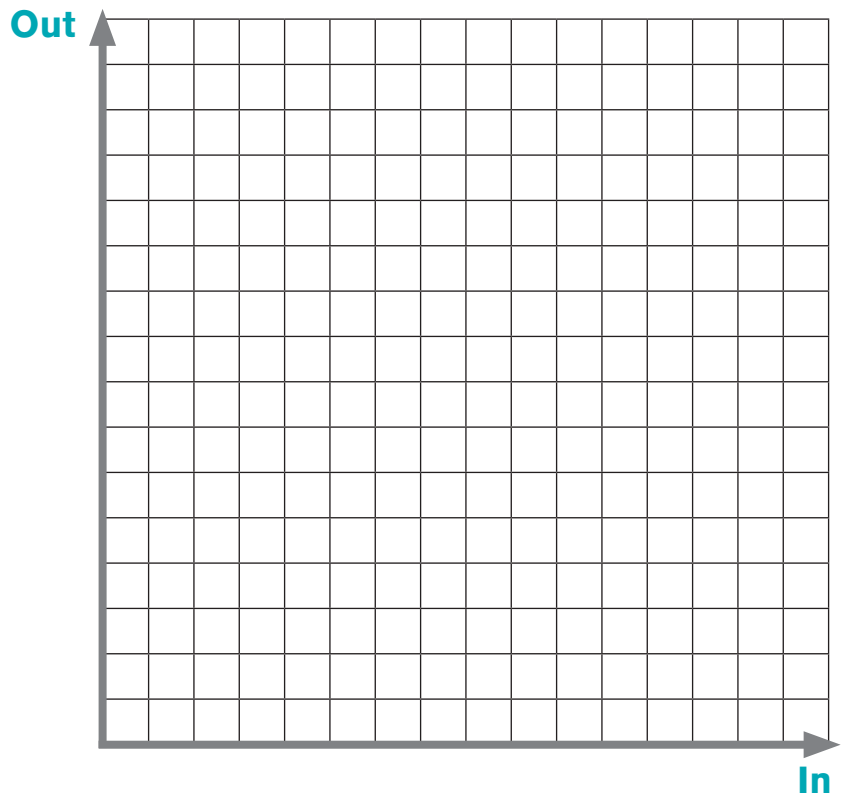

Rule:		
In	Out	Solution
		(16, 14)
		(15, 13)
14		
13		
12		
11		
10		
9		

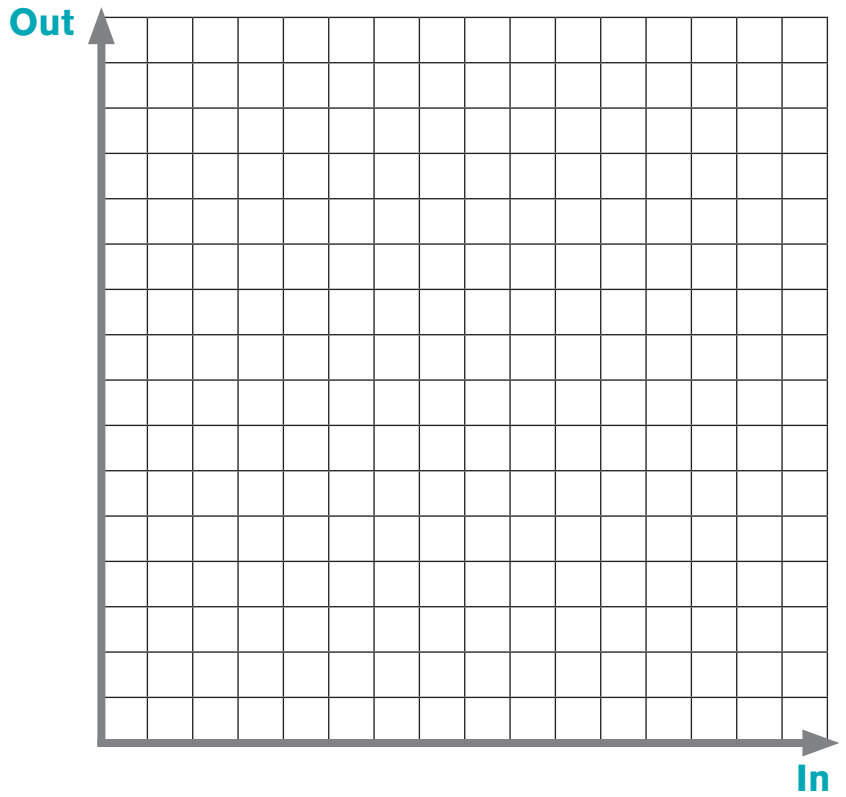

Rule:		
In	Out	Solution

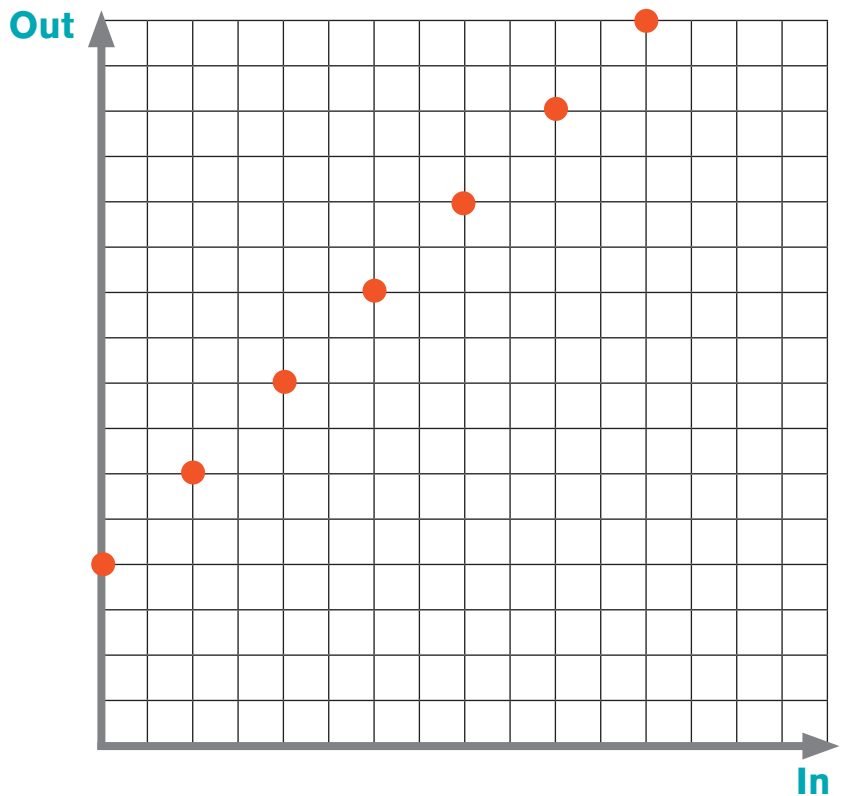

Rule:		
In	Out	Solution
1	2.5	
2	5	
3	7.5	
4		
5		
6		

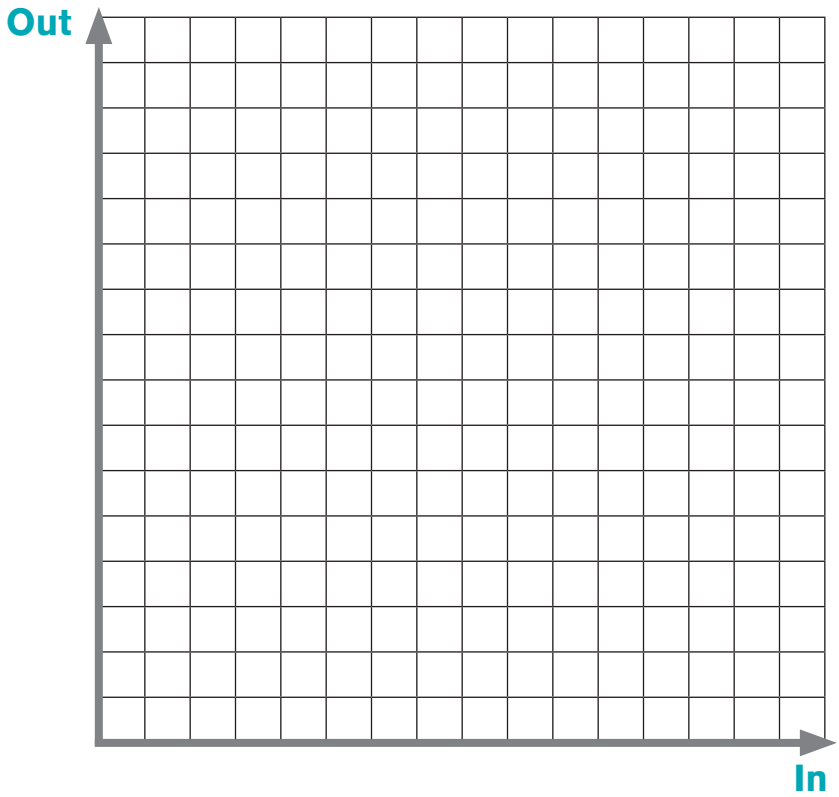

Rule:		
In	Out	Solution

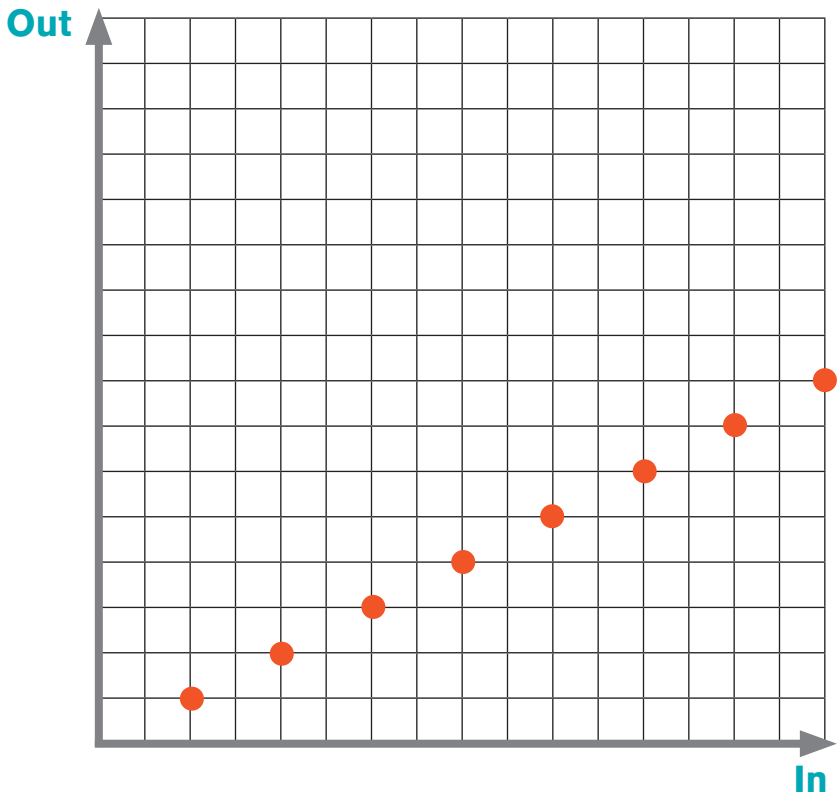

Cooking with Functions

A recipe calls for two cups of water for every one cup of rice.
Use this ratio to guide your reasoning below.

- 1 Complete the table below by determining which of the recipes are correct. Then predict how the rice will turn out based on the ratio.

In	Out	Does the recipe follow the correct ratio? YES or NO	How will the rice taste?
Water	Rice		
2	1		
3	2		
5	2.5		
6	3		
7	2		
9	4.5		
12	4		
13	10		
14	7		

Adapted from EMPower: Keeping Things in Proportion

- 2 Now graph all the points and see whether your predictions were correct.

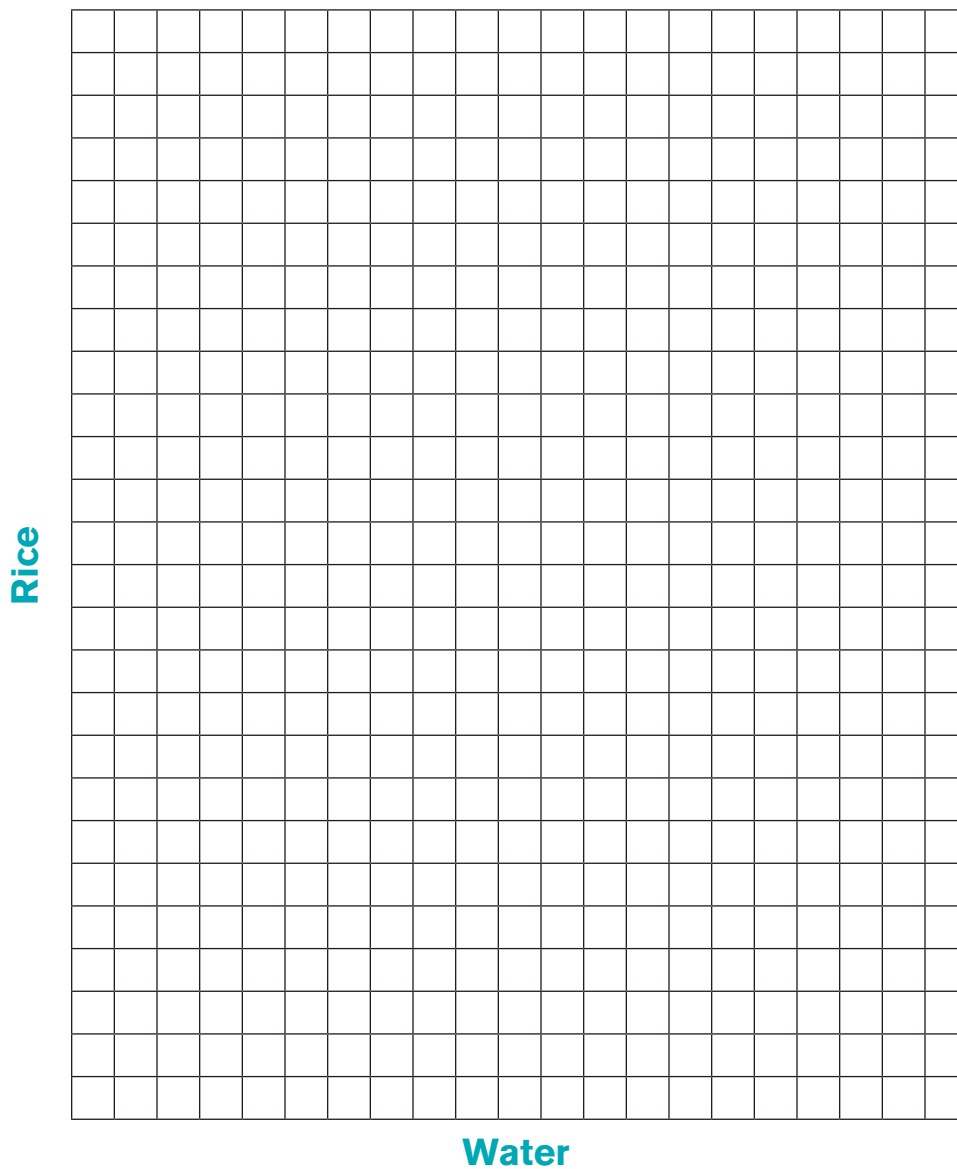

- 3 Look at the graph. What do you notice?

The Cab Fare Problem

Three friends used the same taxi service to meet at a restaurant for dinner. When they arrived at the restaurant, they compared their cab fare and tried to figure out a rule that the taxi company used to calculate cost.

- Denise's trip was only 1 mile and her total cost was \$4.50.
- Mark said that his trip was 6 miles, and his total cost was \$12.00
- Solange's trip was 3 miles, and her total cost was \$7.50
- Kate's trip was 8 miles, and her total cost was \$15.00.

1 Complete the table below for the three passengers.

Passenger	Distance	Cost	Coordinate
Denise			
Solange			
Mark			
Kate			

2 Plot Denise, Mark, Solange, and Kate's costs in the graph below, then draw a line that connects the four coordinates.

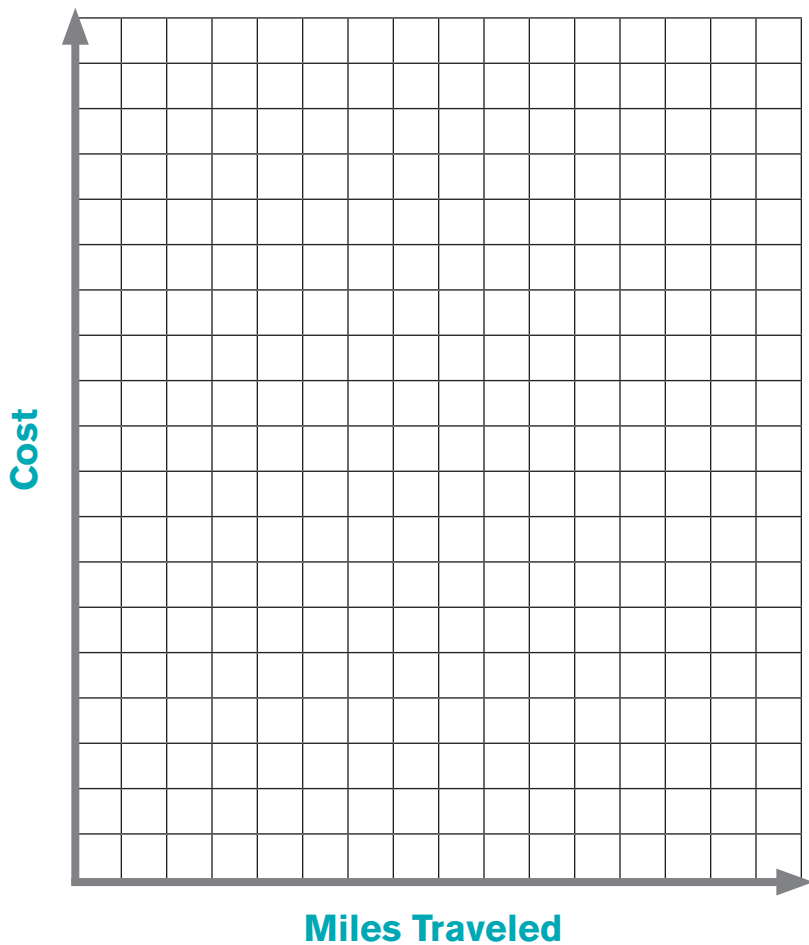

- 3 What would be the total cost for a passenger who travels 10 miles?

- 4 The taxi company charges a base fee and a fee for each mile traveled. What is the base fee, and what is the cost per mile?

Lesson Plan

Rate of change is a fundamental concept when working with functions. Too often it is presented by writing $y = mx + b$ on the board, with m —the rate of change—being defined as the slope. This lesson focuses students on function tables, looking for patterns and making observations. From there, we connect what students see to how the things they observe appear in function rules, and we introduce the vocabulary of “rate of change” and “starting amount,” which can later be referred to as “slope” and “y-intercept.” Before we talk about slope and y-intercept though, we want students to have a flexible understanding of how to identify rate of change and starting amount in tables, rules, and graphs, and to know how they can use these concepts in solving problems.

OBJECTIVES

- ✓ Students will discover the relationship between rate of change, starting amount, and function rules.
- ✓ Students will use rate of change and starting amount to determine function rules from tables.
- ✓ Students will determine rate of change, starting amount, and function rules for contextualized problems.

**COMMON CORE
STANDARDS OF
MATHEMATICAL PRACTICE**

MP1; MP2; MP4;
MP6; MP7; MP8

HANDOUTS

- | | |
|---|-----------------------------|
| 1 • What’s My Rule? | 7 • Exploring Polygons |
| 2 • Discovering Rules 1 | 8 • Weekend Getaway |
| 3 • Discovering Rules 2 | 9 • Counting Cricket Chirps |
| 4 • The Power of the Rate of Change | 10 • Lightning and Thunder |
| 5 • The Many Faces of Functions
(see <i>Teacher Note below</i>) | 11 • Temperature Scales |
| 6 • Counting Antibodies | 12 • Measuring Babble |

KEY VOCABULARY

rate of change: the constant change in the output when the inputs are consecutive

starting amount: the value of the output when the input is zero

ACTIVITY 1 Launch

- 1 This opening activity is crucial to the lesson and cannot be rushed or skipped. You will need at least 45–60 minutes to do the whole thing. The point of this activity is to create the “headache” for which the rate of change discovery will provide the “aspirin.” Like they did with the Function Machine activity in the first unit, students are going to look at abstract function tables and figure out the function rule that fits. The big difference is that most of the rules here have two operations. Though students struggle with this activity, it is productive and they tend to persevere, particularly because it has the elements of a puzzle that they feel motivated to solve.
- 2 Some of your students may be able to get straight to work on these. Others may have a hard time getting started and/or get frustrated easily. You might want to draw the first function table (top-left corner) from the WHAT’S MY RULE? handout on the board and discuss it as a class. Here’s an example of how you might frame your questions:

Teacher: *As I go from the input to the output, how are the numbers changing?*

Students: *They are getting bigger.*

Teacher: *What operations usually make things bigger?*

Students: *Addition and multiplication.*

Teacher: *Ok, let’s try one of those. How could you use addition or multiplication to get from 1 to 5?*

Students: *Add 4.*

Teacher: *Good. Is that the function rule? How do you know?*

Students: *1 + 4 is 5, but 2 + 4 is not 7.*

Teacher: *Okay. Let’s try something else. But first, let’s keep track of all the rules we try.*

*(Write “+4” on the side of the table and cross it out.)
What else can we do to get from 1 to 5?*

Students: *Multiply by 5.*

Teacher: *Good. Is that the rule for this function? And how do you know?*

Students: *No, because 2 times 5 is not 7. It doesn't work for the other inputs and outputs.*

Teacher: *Good. Add that to the list of rules we've tried so far. So it looks like we are going to need a two-step rule. How can we use multiplication and addition together to get from 1 to 5?*

Students: *?*

Teacher: *When you multiplied 2 by 5, was the output too big or too small?*

Students: *Too big.*

Teacher: *So what is another number we could multiply by?*

Students: *4?*

Teacher: *Excellent! Let's try it. If you put the 1 in and multiply by 4, what do you need to do to get the output?*

- 3** Walk around the room as students are looking for the rules that fit each function table. Encourage them to keep track of their guesses in the space on the side of the function tables or on a separate piece of paper. After they come up with a rule or two, ask them if keeping track of their guesses has been helpful.
- 4** If any students happen to notice the constant change in the outputs when the inputs are consecutive, congratulate them and say that is an important observation that the class will come back to later. But don't make too much of it at this point.
- 5** It will probably take your class about 45 minutes to complete the sheet. If you have a few students who finish early, make sure the rest of the class still has time to struggle through the handout. This handout is a good equalizer in some ways, so it is unlikely that you will have anyone who finishes too fast. For those who do, I like to ask them to spend a few minutes to play the Function Game from the Introducing Functions lesson in Unit 1. After working hard, students enjoy the thought of trying to stump their teacher.
- 6** Once everyone is done, write the function tables on the board or on newsprint. If you only have time to write some of them, focus on the ones that have two-step rules. Now ask different students come up and add the function rules they found. Make sure that the whole class agrees on the correct rule for each table, and then ask for volunteers to explain why each rule is correct.

- 7 As a final piece, ask students to reflect on the process. Ask them, *How did it feel working on finding these rules?* and *What strategies were helpful to you?*

ACTIVITY 2 Rate of Change Discovery

- 1 Tell students they are going to spend some time looking at functions rules and tables to see if they notice any patterns that might help them find rules in the future. Distribute the handout DISCOVERING RULES 1 and have students use the function rules to complete the tables. Once they are done, ask them, *“What do you notice about these two functions? How are they similar? How are they different?”* Some possible student responses:

- *The outputs for both alternate between odd and even numbers.*
- *They both have $\times 3$ in the rule.*
- *The outputs for both functions go up by 3.*
- *The inputs for both functions go up by 1.* (See if there is a student who knows the math word for this. If not you can introduce the word *consecutive*.)
- *The outputs on the right are 4 larger than the ones on the left.*

- 2 We want to draw their attention to the difference in the outputs. Once students have observed this difference, we can introduce the formal name. Ask students to write the following definition on their handout, and tell them that this is a crucial concept in functions:

The rate of change is the constant change in the outputs when the inputs are consecutive.

For both of these functions the rate of change is 3. That means the outputs grow by 3 when the inputs are consecutive.

- 3 Ask your students if the rate of change of 3 is visible anywhere else, aside from the constant change in the outputs. We want them to notice that the rate of change appears in two places: the table and the rule.
- 4 Have students look back at the function tables from the Activity 1 Launch and ask them to identify the rate of change for each function. Make sure they can identify the rate of change in both the rule and the table. Almost all of the tables have consecutive inputs,

but two do not: “ $\times 2 + 4$ ” and “ $\times 3 + 4$.” For both of those, if students don’t raise it themselves, ask why only the first 4 outputs show the rate of change of 2 and 3, respectively. We want students to notice that when the inputs are not consecutive, the rate of change is not visible in the same way as when the inputs are consecutive.

- 5 You can talk about this more here, though students will have an opportunity to explore this idea further during Activity 4. If you want to pursue it, you might look at the function table from the launch for the function “ $\times 2 + 4$ ”. The first four inputs are consecutive, so you can easily observe the rate of change of 2. But then the inputs jump from 4 to 9. And as the inputs make that jump, the outputs go from 12 to 22. You can have students figure out the outputs for the missing inputs of 5, 6, 7, and 8.

ACTIVITY 3 Starting Amount Discovery

- 1 Give out DISCOVERING RULES 2 and give students time to complete the tables. Ask them to identify the rate of change for each function, and make sure they can see it in both the table and in each rule.
- 2 Now, ask students to make observations about the similarities and differences between the two functions in the same way you did for the rate of change discovery. The one observation you want to focus in on is the fact that both functions share one solution: (0, 4). They may also notice that both functions have a “+ 4” in the rule. You can ask them how the output could be the same for both of them if they have different function rules (and different rates of change). If the input is 0, it will knock out the first part of the function, since anything times 0 is 0. That leaves you with the + 4.
- 3 Next, tell students that the shared solution is our second important function concept of the day. Ask students to write the following definition on the DISCOVERING RULES 2 handout:

**The starting amount is the value of the
output when the input is zero.**

Again, look back at the function tables from Activity 1 and find the starting amount for each function. They should be able to find it in the rule for all of them. For each table that doesn’t have an input of 0, ask students what would come out if you put a 0 into that function rule.

ACTIVITY 4 **The Power of Rate of Change**

- 1 Give students an opportunity to recognize the implications of these two concepts. Have them work on THE POWER OF RATE OF CHANGE handout.
- 2 The two functions tables on the top of the page have consecutive inputs while the two on the bottom do not. You should not mention this to students. In this activity, we want students to feel the speed and efficiency with which their new knowledge will allow them to come up with function rules. We also want them to make an important mistake. The function table on the bottom left has the same outputs as the function table above it. Many students will write the same function rule for both because they don't notice the inputs on the bottom one are not consecutive. This is an important mistake and you should not take away their opportunity to make it and reflect on it. Most students will struggle with the function table on the bottom right. Most will work on it as they would have worked on all tables before they know about rate of change and starting amount—guessing and checking rules. That is a fine strategy while they are working. It is not necessary for everyone to have gotten that last function rule before debriefing.
- 3 Have students come up, share their rule and explain how they got it for the first two functions. Make sure to ask the class how we know each rule works—does it work for all of the given inputs and outputs?
- 4 Ask the class how knowing about rate of change and starting amount impacts their abilities to come up with two-step function rules.
- 5 Write the function table from the bottom left up on the board. Ask if anyone found a rule for it. Then ask if anyone came up with a different rule. The most common answer is likely to be " $\times 4 + 6$ ". Some students may have come up with the correct answer—" $\times 2 + 6$ ". If you get both, write them both on the board without revealing which one is correct. Ask them which one fits all of the inputs and outputs in the table and they will see it is " $\times 2 + 6$ ". Ask them about why they think the " $\times 4 + 6$ "—which will be the most common answer—doesn't work. We want them to recognize that the inputs being consecutive is an important part of the rate of change. To help students see the rate of change of 2, you can add the "missing" numbers to make the inputs consecutive.

- 6 The function table on the bottom right is tricky because the inputs are not in size order, and they are not consecutive. Most students will assume this means the rate of change cannot be determined. We want them to notice that there are two pairs of inputs that are consecutive, if they rearrange the order of the inputs—the 8 and 9 and the 4 and 5. From there, they can identify the rate of change of 4.
- 7 From this point on, you should always ask students to identify the starting amount and rate of change for every function they look at.

TEACHER NOTE: INTRODUCING FORMAL FUNCTION NOTATION

We have purposely held back on introducing formal notation of functions before now. We believe it is important for students to have a strong foundation in the concepts of the functions—the function machine model, the three views of a function, rate of change and starting amount—before they move into some of the more abstract notation. That said, at some point we do need to introduce our students (at least those at the HSE level) to the notation they are likely to encounter during the exam.

If you are working with lower-level students, or if you think you want to keep your students working on the foundational concepts, you will have to adapt the handouts for the rest of this unit, which all employ more formal notation.

We are including an activity titled, “The Many Faces of Function Rules” to help you and your students make the transition and be comfortable with different ways of writing function rules. If you feel your students are ready, this is a good moment in their function study to do so.

As they work through this activity, a good way to keep students centered is to ask them, for each different version of the rule, what is different and what is the same. The principles of inputs

and outputs are the same. The rate of change is the same. The starting amount is the same. If students get thrown by the new notation, have them focus on translating it back to a form they are comfortable with.

The first change is to write the function rule as an equation—including the words “In” and “Out” in the rule. The next change is writing the table horizontally. The third change is to substitute x for the In and y for the Out. The next major change is on the last page: $p=10c + 120$. We want students to realize that x and y are the most commonly used variables to represent, but that other variables can be used as well. We also want them to see that regardless of what variables are used, we can tell which are the inputs and which are the outputs by where they appear in the rule and the table. The final change might be the strangest looking, but it is one that students are likely to see on their HSE exam.

$f(x) = 6x + 5$ can be read as “ f of x is $6x + 5$,” or “the function of x is equal to $6x + 5$.” Also, you can ask for an output in the following way: “For the function $f(x) = 6x + 5$, what is $f(21)$?” which means, “If you put a 21 into this function, what comes out?”

ACTIVITY 5**Looking at Functions in Real-World Contexts**

Following are seven activities, each of which give students a chance to use their understanding of rates of change and starting amounts to determine rules. Additionally, they all allow students to consider the meaning of rate of change and starting amounts in real-life contexts. They also give students an opportunity to both work with function rules that describe real-world situations and which are written in formal notation.

Below are brief descriptions of each activity. Teachers should use the descriptions to decide which activities you want your students to do and how you might have students work on them. You can certainly have your students work on all of them, but that would likely take several classes.

Counting Antibodies

This is the most comprehensive activity, with the widest variety of different questions. It deals with a health care situation in which a scientist is testing two medicines to determine their effect on the number of antibodies in the blood sample of a patient. Students have to use a function rule to complete a table, come up with an output for a given input not in the table, find an input for a given output, find the rate of change and starting amount for two different functions, create a function rule from a function table, come up with a solution that does not fit a function rule, graph two functions, interpret a point of intersection and make a choice based on their work, all within the context of a contextualized healthcare situation.

Exploring Polygons

This activity incorporates some geometry into our function exploration. You should make sure all of your students understand the column that reads “Sum of the interior angles”. You might have them use the pictures on the top to mark the interior angles. You might even have them calculate the measure of each interior angle, given that the polygons are regular (and therefore have equal angles).

This activity is more open than *Counting Antibodies* and allows for a few different solution methods. Whichever methods students use, make sure to raise using the rate of change to determine the rule as one option.

Weekend Getaway

This activity gives students a chance to work with a rate of change that is a decimal. They will have to complete a table, come up with a rule, plug an input into the rule, find an input for a given output, and interpret both the rate of change and the starting amount in the context of the situation—which is about the cost of renting a car.

Counting Cricket Chirps

There is a relationship between the number of times a cricket chirps per minute and the temperature. This activity involves a function that describes that relationship. It gives students another opportunity to work with inputs that are not consecutive, to discuss the inputs and outputs in the context of the situation, to find the rate of change, and to consider the domain of the function. The domain of a function is the set of inputs for which the function is defined. You can put any number into the cricket function, but any number less than 40° will result in a negative number of chirps per minute—fun to think about, but not actually possible.

Lightning and Thunder

This is another function with connections to science. This time students are looking for a function rule that describes the relationship between the distance between you and a lightning strike and the amount of time it takes for the sound of the thunder to reach you. This one also involves a rate of change that is less than one—expressed as $1/5$ or 0.2 . Like *Exploring Polygons*, this activity is open and the questions can be answered without determining a function rule. If no one uses that strategy, I would pursue it after they have presented all of their methods.

Temperature Scales

This activity is also has science connections—it involves a chart with information about temperature equivalencies between Celsius, Fahrenheit, and Kelvin. It is another opportunity for students to work with inputs that are not consecutive. Depending on which conversion you are making, it will also involve a fraction as the rate of change. This activity also allows students to write their own questions. You can have them share them with the whole class, or write them on the board. Then you can have the students chose a question or two they want to work on. It is a nice way for students at all different levels to be engaged in the same activity. As with *Exploring Polygons* and *Lightning & Thunder*, there is no explicit question asking students to determine a function rule for converting Celsius to Fahrenheit. You can raise this question to the class, use it as a bonus question, or have it as an extension for students who finish early.

Measuring Babble

This activity is different in that it is the only one with a negative rate of change. It deals with a politician who wants to make her opponent look bad in front of the press. The function describes the rate at which an audience leaves a speech over time. Given the starting amount, students need to figure out what time to invite the press to come hear the speech so that no one is left.

What's My Rule?

Fill in the missing values. All rules use whole numbers.

Rule:	
In	Out
1	5
2	7
3	9
4	11
5	13
6	15

Rule:		
In	Out	Solution
		(0, 0)
		(1, 7)
		(2, 14)
		(3, 21)
		(4, 28)
		(5, 35)

Rule:		
In	Out	Solution
1	9	
2	15	
3	21	
4	27	
5	33	

Rule:	
In	Out
0	2
1	7
2	12
3	17
4	22

Rule:		
In	Out	Solution
		(1, 3)
2	6	
		(3, 9)
4	12	
		(5, 15)
6	18	

Rule:	
In	Out
0	1
1	7
2	13
3	19
4	25
5	31

Rule:	
In	Out
1	6
2	8
3	10
4	12
9	

Rule:		
In	Out	Solution
		(0, 4)
		(1, 7)
		(2, 10)
		(3, 13)
100		

Discovering Rules 1

Fill in the missing values.

Function: $\times 3 + 1$	
In	Out
1	
2	
3	
4	
5	
6	

Function: $\times 3 + 5$	
In	Out
1	
2	
3	
4	
5	
6	

Discovering Rules 2

Fill in the missing values.

Function: $\times 5 + 4$	
In	Out
0	
1	
2	
3	
4	
5	

Function: $\times 2 + 4$	
In	Out
0	
1	
2	
3	
4	
5	

The Power of Rate of Change

Function:	
In	Out
0	6
1	10
2	14
3	18
4	22
5	26

Function:	
In	Out
0	7
1	10
2	13
3	16
4	19
5	22

Function:	
In	Out
0	6
2	10
4	14
6	18
8	22
10	26

Function:	
In	Out
1	13
11	53
8	41
5	29
9	45

The Many Faces of Function Rules and Tables

Textbooks, teachers, and professors may differ in their visual display of function rules and tables. Below, you will find several different function rule and table formats. Even though some will look different from the rules and tables you have seen up until now, the input-output principles are the same.

1

Rule: Out = In × 6 + 2	
In	Out

2 Out =

In	1	2	5	8	20	
Out	11	19	43			99

3 This function rule is the same as the following:

Out = In × 4 + 1

Notice that x indicates the input, and y indicates the output. When a number is written immediately in front of x , this indicates multiplication of the number and x . For example, $4x$ means “4 times x ”.

Function: $y = 4x + 1$	
x	y
0	
2	
6	
	49
	61
	121

4 This function rule is the same as the following:

Out =

Function: $y = 5x - 2$	
x	y
1	
2	
6	
	48

5 Re-write this function rule in In/Out format:

Out =

Function: $y = 5x + 1$	
x	y
0	
1	
2	
3	
	56
	101

6 Re-write this function rule in In/Out format: $y = 10x + 20$

Out =

x	0	1	2	7	11		
y						60	140

7 Re-write this function rule in In/Out format:

Out =

Function: $y = 25x + 10$	
<i>x</i>	<i>y</i>
4	
6	
9	
	17.50
	10

8 Re-write this function rule in In/Out format:

Out =

Function: $y =$	
<i>x</i>	<i>y</i>
1	8
2	11
3	14
4	17
6	
	38

9 Re-write this function rule in In/Out format:

Out =

Function: $y =$	
<i>x</i>	<i>y</i>
1	10
2	17
3	24
4	31
6	
	59

- 10 Re-write this function rule in In/Out format:

Out =

Function: $p = 10c + 120$	
c	p
0	
1	
2	
10	
.5	
	270
	620

- 11* Re-write this function rule in x/y format:

y =

Rewrite this function rule in In/Out format:

Out =

Function: $f(x) = 6x + 5$	
x	f(x)
0	
1	
2	
10	
.5	

Counting Antibodies

A scientist tested a medicine in order to determine how effective it is in producing antibodies. The following is a function that represents the number of antibodies in a sample of blood from a patient:

$$a = 20d + 100$$

In this function, d represents the number of days that passed in the experiment, and a represents the number of antibodies in a sample of the patient's blood.

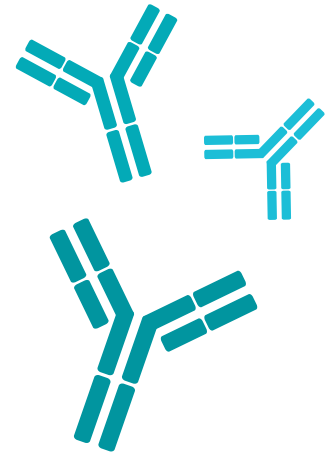

Antibodies are y-shaped molecules of the immune system.

- 1 Complete the table of values for this function.

Data for Medicine A	
Days Passed	Antibodies in the Sample of Blood
d	a
0	
1	
2	
3	
4	
5	

- 2 How many antibodies were there in the sample after ten days? Show how you calculated your answer.
- 3 How many days did it take for 360 antibodies to appear in the patient's blood sample? Show how you calculated your answer.

- 4 How many antibodies were there at the beginning of the experiment? Show how you calculated your answer.
- 5 What is the rate of change for this function? How can it be interpreted using the context of the problem? In other words, can you describe the rate of change in terms of “days” and the “number of antibodies”?
- 6 Identify an ordered pair that would not be a solution to this function. Explain why it is not a function solution.

The scientist tested a different medicine, and recorded the following data after following a patient for several days.

Data for Medicine B	
Days Passed	Antibodies in the Sample of Blood
0	60
1	90
2	120
3	150
4	180
5	210
6	240

- 7 If the growth of antibodies continues at the rate shown in the table, predict the number of antibodies in the blood sample after 12 days. Show how you calculated your answer.
- 8 How many days would be needed to produce 600 antibodies in the patient's blood sample at this same rate? Show how you calculated your answer.
- 9 Find a function rule that describes the data, where d represents the number of days that passed in the experiment, and a represents the number of antibodies in a sample of blood from a patient.
- 10 What is the starting amount for this function? How can it be interpreted using the context of the problem? In other words, can you describe the starting amount in terms of “days” and the “number of antibodies”?
- 11 What is the **rate of change** for this function? How can it be interpreted using the context of the problem?

12 If you were ill and you had both medicines to choose from, which would you choose? Why?

13 Create a line graph with the data for both medicines. Use pencil. Use a triangular symbol for each point for Medicine A. Use a circular point for Medicine B.

Comparing Antibody Production of Two Medicines

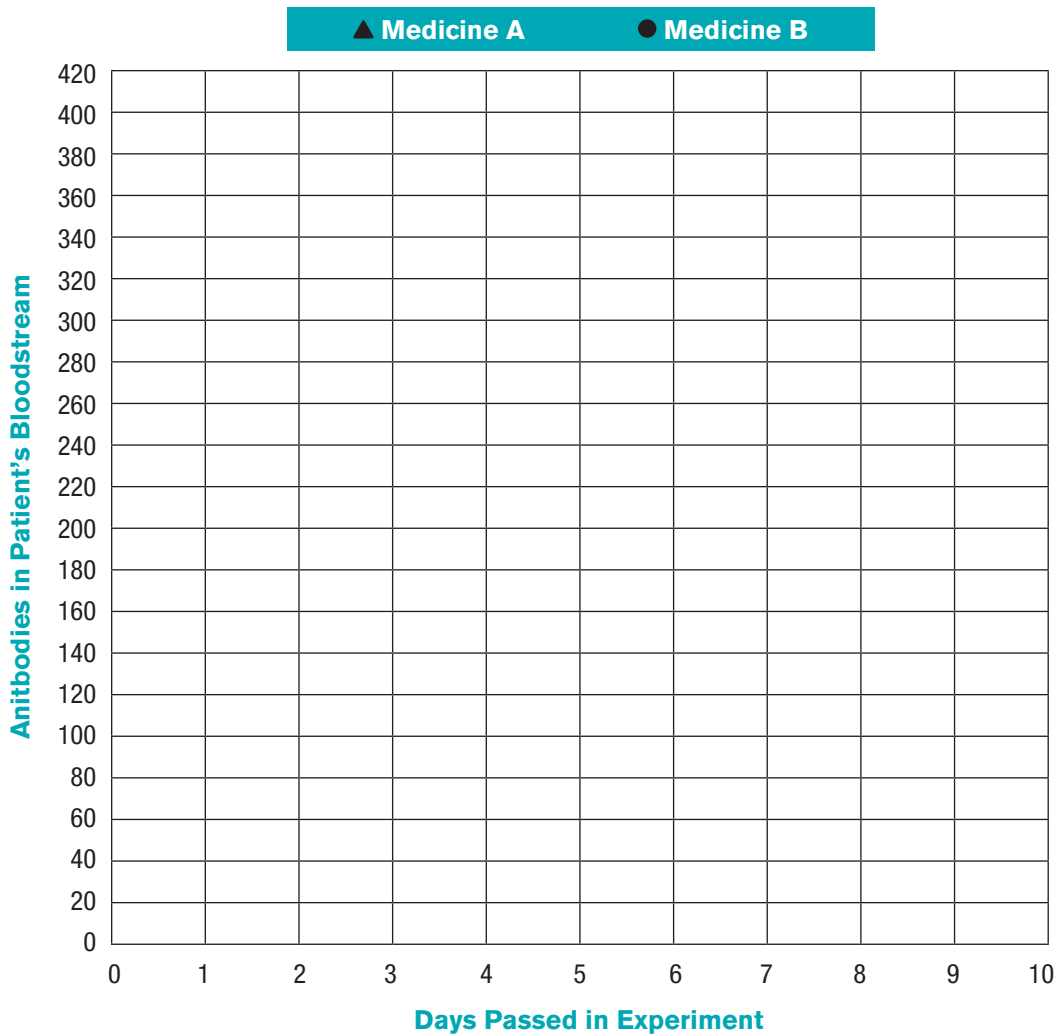

- 14 What is the significance of the place on the graph where the two lines intersect?

- 15 On the graph, use arrows to indicate the point that represents the starting amount for each function.

Exploring Polygons

A regular polygon is a polygon that has equal sides and equal angles. Some regular polygons are shown below. Name them based on the number of sides they have.



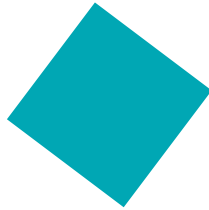



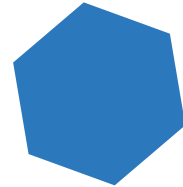

The table to the right has information on the sum of the interior angles for different polygons. What do you notice? Are there any patterns you see?

Number of Sides in the Polygon	Sum of the Interior Angles
3	180°
4	360°
5	540°
6	720°
7	900°
8	1080°

1 What will be the sum of the interior angles of a polygon that has 24 sides? Be prepared to show how your group determined your answer.

2 How many sides will a polygon have that has an interior angle sum of 2700°? Be prepared to show how your group determined your answer.

Weekend Getaway

You need to rent a car for the weekend. You locate the following advertisement for a local rental agency.

Using the information from the advertisement, complete the table at the right.

BROOKLYN'S BEST CAR RENTAL

Special Weekend Price!

One mid-sized car rental
for a flat rate of \$96
plus \$0.12 per mile

- Determine the function that shows the costs of renting a mid-sized car from *Brooklyn's Best Car Rentals*, where the inputs (x) represent the number of miles driven, and the outputs (y) represent the weekend rental charge in dollars.
- What would be the cost in dollars, not including taxes or insurance, of renting a car and driving it a total of 200 miles over the weekend? You may use a calculator if you wish, but show here what calculations you made to determine your answer.
- After you rent the car for the weekend, *Brooklyn's Best Car Rentals* presents you with a bill for \$110.88, not including taxes or insurance. How many miles are they claiming you drove? Show how you determined your answer.
- What is the **rate of change** for this function? How can it be interpreted using the problem context?
- What is the **starting amount** for this function? How can it be interpreted using the problem context?

x	y
Miles Driven	Total Rental Charge (\$)
0	
1	
2	
3	
4	
5	

Counting Cricket Chirps

The speed at which crickets chirp is based on the temperature. The following function is a pretty good measure of the number of chirps per minute depending on the temperature:

$$c = 4t - 150$$

where t represents the temperature in degrees Fahrenheit and c represents the number of cricket chirps per minute. Complete the data table for this function below.

t	40	50	60	70	80	90	100
c			90				

- 1 When the value of t is 60, the value of c is 90. Explain what this means using the problem context.
- 2 What is the **rate of change** for this function? (*Be careful!*)
How can it be interpreted using the problem context?
- 3 What is the **starting amount** for this function? Does it make sense given the context of this problem? Why or why not?

Lightning and Thunder

Thunder is the sound produced by lightning. When you see a lightning bolt, you can figure out how far away it is by counting the seconds before you hear the thunder. The farther away the storm, the more time there will be between seeing the lightning and hearing the thunder.

A person standing $\frac{1}{5}$ (or .2) of a mile away will hear the thunder approximately 1 second after the lightning strikes.



Lightning travels at 90,000 miles/sec!

- 1 If there was 30 seconds between the time you saw the lightning and when you heard the thunder, how far away was the lightning strike?

- 2 If a lightning strike is 8 miles away, how many seconds would pass before you are able to hear it?

- 3 All sounds travel at the same speed. Using what you know about thunder, what is the approximate speed of sound, in miles per hour?

Time (in seconds)	Distance (in miles)

Temperature Scales

There are three main ways used to measure temperature—Celsius, Fahrenheit, and Kelvin.

Celsius (C°)	Fahrenheit (F°)	Kelvin (K°)	
0°	32°	273°	Freezing point of water / Melting point of ice
10°	50°	283°	
20°	68°	293°	Average room temperature
30°	86°	303°	
40°	104°	313°	
50°	122°	323°	
60°	140°	333°	
70°	158°	343°	
80°	176°	353°	
90°	194°	363°	
100°	212°	373°	Boiling point of water (at sea level)

- 1 If it is 25° Celsius, what is the temperature in Fahrenheit?
- 2 If it is 28° Celsius, what is the temperature in Fahrenheit?
- 3 Write three questions based on the table above.

Measuring Babble

Congressman Babble recently gave a speech outlining his new policy proposals. A researcher recorded the number of people listening by counting how many both stayed in their seats and remained awake.

The following function was created to describe the number of listeners:

$$l = 600 - 15m$$

where m represents the number of minutes that Congressman Babble was speaking, and l represents the number of listeners.



Congressman Babble moments before his speech.

- 1 Complete the table of values.
- 2 Ms. Clark is challenging Congressman Babble in the next election. She wanted to bring reporters to Congressman Babble's speech exactly when no one was left listening. If the speech began at 10:00 a.m., at what time should she have walked in with the reporters? Show how you reached your answer.

m	l
0	
5	
10	
15	

- 3 What is the **starting amount** for this function? How can it be interpreted using the problem context? In other words, can you describe the starting amount in terms of “number of minutes passed in the speech” and the “number of listeners”?
- 4 What is the **rate of change** for this function? How can it be interpreted using the problem context?
- 5 Is (22, 270) a solution to this function? Explain why or why not.

“ Understanding takes place in students’ minds as they connect new information with previously developed ideas, and teaching through problem-solving is a powerful way to promote this kind of thinking. Teachers can help guide their students, but understanding occurs as a by-product of solving problems and reflecting on the thinking that went into those problem solutions.”

–Diana Lambdin

Systems of Equations: Making and Justifying Choices

Systems of equations appear frequently on the HSE exam, as well as almost all college-entrance exams. Our students really struggle with this material, especially since it is so often introduced without any real-world context or discussion of its usefulness. However, developing an understanding of how systems of equations work can pay big dividends both in and out of the classroom. The problems in this unit use real-world scenarios to present a scaffolded introduction to the topic. Students will continue to explore the many different views of functions, and they will learn how systems of equations can be a useful tool for drawing conclusions and justifying choices.

SKILLS DEVELOPED

- Writing systems of equations in two variables.
- Using tables and graphs to compare two linear functions.
- Understanding the significance of the point on the graph where two lines intersect.
- Using tables, graphs, and guess & check to find solutions to systems of linear functions.
- Seeing applications of systems of equations in science and social studies contexts.
- Using systems of equations to make and justify choices.
- Interpreting systems of equations as a means of negotiation between competing interests.

KEY VOCABULARY

equation: a math statement showing that two expressions are equal to one another.

solution to a system of equations: values that satisfy all equations in a system. The solution to a system of linear equations can be represented by a point in the coordinate plane.

system of equations: a collection of two or more equations that we have to consider at once. This unit will focus on systems with only two equations.

Core Problem Overview: Choosing a Cell Phone Plan

The previous core problems have incorporated tables, rules, and graphs to develop understanding of functions. This core problem goes a step further by asking students to reflect on the meaning of the point where two lines on a graph intersect. Before giving out the problem, ask students how they chose their cell phone plans. After students have shared some ideas, tell them we can use functions as a way to make comparisons and decisions and that they'll be looking at two options for a cell phone plan. *Choosing a Cell Phone Plan* presents students with advertisements from two competing wireless service providers. Each provider charges a base fee—\$60 for PEMDAS Wireless and \$40 for CCSS Mobile—and a fee for each additional gigabyte of data used. Through a series of scaffolded questions, students will explore how the total cost for each provider grows as data usage increases.

PEMDAS Wireless		CCSS Mobile	
Gigabytes	Total Cost	Gigabytes	Total Cost
0	\$60	0	\$40
1	\$62	1	\$44
2	\$64	2	\$48
3	\$66	3	\$52
4	\$68	4	\$56

Students will first interact with the problem by doing something that should be familiar by this point: completing a table of values. Some students will notice a pattern and complete these tables rather quickly, though others might need some support in order to understand how the price structure works for each provider. At this point, they are asked to make a choice about which provider they would choose based on the information in their tables. Most students will choose CCSS mobile, because the total cost is lower for every one of the inputs in the tables. Some might notice, though, that the cost of CCSS Mobile grows more quickly than it does for PEMDAS Wireless. The next two questions ask students to clarify what the starting point and rate of change are for each provider—both of these are intended to help students get closer to creating a rule that they could use to find the total cost for each company.

The rule that students create will help them to complete another table. This table uses bigger input values and will be the one students use to

construct a graph of the two functions. After students have graphed the lines for both providers, they will answer some questions intended to draw out their thinking about the shapes of the graphs and the point at which they intersect. The question at the end of this activity—about which provider has the best offer—is similar to one that they answered at the beginning, but we’re looking for students to show a more nuanced understanding this time around.

TEACHING THE CORE PROBLEM

Depending on how much time your class has spent completing tables and working on functions, it might be worthwhile to have a conversation about the two advertisements before they start working. This will give students the opportunity to hear what their classmates think and may also help them to see something that they didn’t see at first. To start, tell the class that they have two minutes to look over the ads, but not to write anything down yet. When time is up, ask them what they noticed. Some possible questions to get the discussion started are:

- *Which of these providers do you think would be the least expensive? Why?*
- *Think about your own phone bill and data usage. Do you use a lot of data, or a little?*
- *Can someone explain how your phone bill would work if you went with PEMDAS Wireless? What about CCSS Mobile?*

Now that students have had the opportunity to talk and get interested in the situation, ask them to work independently. As they’re working, make note of student answers to the second question—“Which provider would you choose? Why?”—and have them explain their reasoning. Most students will say that they would choose CCSS Mobile, but they should explain why they would make that choice. If they say, “because it’s cheaper,” ask them if they think it will always be cheaper. Or ask, *What if a person used a lot of data, like 12 gigabytes? Do you think it would still be cheaper?*

The next two questions ask about “starting amount” and “rate of change.” These topics are introduced in Unit 3, and so if you haven’t done these yet, you might choose to remove these two questions from the activity. It’s a good idea to make sure that students give more than a numerical answer for these questions. That is, if a student just writes “60” for PEMDAS’s starting amount, ask them to write a little about what that means. You’re looking for something like, *“I would have to pay \$60 even if I don’t use any data, and then it gets more expensive from there.”* The same goes for their answer about the rate of change. You want students to talk explicitly about how, for example, CCSS

Mobile costs \$4 more for each additional gigabyte of data used. The rate of change is included in the advertisement, but it's a good idea to encourage students to put this into their own words. It will help them when they take on the next task: creating a rule for each provider.

You may or may not have dug into variables and function notation with your class yet. If you have, you can encourage students to write their rules in function notation. So, the function for PEMDAS Wireless would look like $f(x) = 2x + 60$, and the function for CCSS Mobile would look like $f(x) = 4x + 40$. If you haven't discussed function notation or variables, ask your students to write out the process they could use to calculate the total cost for the two providers. The rule for CCSS Mobile might read something like, "Multiply the number of gigabytes by 4, and then add 40." Your students will be able to complete the activity—and gain insight into how systems of equations work—whether they use function notation or not. Try to meet your students where they are and support the method that they are using.

For the last part of the activity, students will use their rules to complete a larger table, and then they will graph each of the points from the table. Your students might need some support with the graphing aspect of this problem, depending on how much graphing work they have done up to this point. If students are struggling, help them to remember another similar graph that they have done in class. You might ask, "*When have we seen a graph like this before?*" Then help them to remember the *Commission Problem* (or one of the supplemental problems) from Unit 2. It's a good idea to check in with each student while they are graphing, to make sure they're plotting points correctly and that they recognize that each company's graph should form a line. After students have finished their graphs and answered the last two questions, move on to the processing part of the activity. This is where you have the opportunity to help your students develop a real understanding of why systems of equations are useful.

PROCESSING THE PROBLEM

Because this problem is so scaffolded, there is not a lot of room for students to take significantly different approaches in solving it. This is helpful, though, in keeping the whole-class discussion focused on the meaning of the point where the two lines meet. To get the discussion started, ask some general questions about the graphs:

- *What do you notice about these two graphs?*
- *How are the graphs similar? How are they different?*
- *Which company's graph has a steeper line? Why is it steeper?*

Once you have allowed students to discuss their thoughts about the two graphs, ask them to focus on the point where the two graphs meet. Here, you might ask for volunteers to share their answer to question number 8 from the activity. Your goal is for students to see that if you were to use 10 gigabytes of data, both companies would have the same monthly cost. As a few volunteers talk about this, ask clarifying questions to make sure that all students are following along.

- *Can someone restate what she just said?*
- *What questions do you have about this point of intersection?*
- *How would we write this point as a solution?*

When the class has come to an agreement about this solution, write it on the board. To help students develop stronger connections between the point of intersection and the rules that they developed earlier, ask for volunteers to read their rules. You should record these on the board and ask the class if they agree with the rule for each provider. Next, ask students to plug in 10 gigabytes as the input for each, and they will see that the outputs are the same. Explain to them that this is the big idea in systems of equations: finding an input that will produce the same output for both equations. Point out that the solution that fits both functions can be found in the table, or by plugging inputs into the rules, or by looking for the point of intersection on the graph.

Now, you should feel free to open the discussion up to other aspects of the graph, and you can begin by asking students to share their answers to the last question from the handout. By looking at the graph and the table, students should talk about how PEMDAS Wireless is a better deal if you plan to use more than 10 gigabytes of data; otherwise, CCSS Mobile would be the best choice. You could also ask students to write their own word problems about the graph, and then have the class solve them together. If your students are looking for an additional challenge, create another advertisement and ask if it will intersect at the same point as the other two lines. You might try the one on the right.

And finally, if you have done the *Commission Problem* already, this would be a good time to ask students to think about how the two problems are similar and how they are different. Help your students to see connections between the work they did on the *Commission Problem* and the work they did on this one. You could ask questions like:

- *What do you remember about working on the Eric and Nancy problem? Did it help you with this one?*
- *Which one was more challenging? Why?*
- *Try to remember the graph of Eric's income and Nancy's income. Did it look like this graph? In what ways was it similar?*

**HSE
CELLULAR**

\$67.50 per month

**\$1.25 per gigabyte
of data**

SIGN UP NOW!

- *What mathematical tools did you have this time around that you didn't have when you worked on the Eric and Nancy problem?*

SUPPLEMENTAL PROBLEMS

- **The Price of Math Books**

This problem is similar to the core problem in terms of its structure and mathematical content, but it also helps students to see how systems of equations have real-world application and it builds their background knowledge about a fundamental concept in economics: supply and demand. The numbers used in this problem are small, so that students can plot supply and demand on a standard one-quadrant graph. After students have done this activity, you could talk about how supply and demand actually operates on a much larger scale. They can think of these numbers as being a small sample that is used to represent a bigger picture, and you could lead this into a discussion of proportional reasoning. One idea might be to tell students that this represents the supply for just one store, and then ask them to calculate the publisher's expected revenue for 1,500 stores.

- **Picking Apples**

This problem is also similar to the core problem, but it incorporates decimals. It also emphasizes the idea that systems of equations can be used to make choices. This time, however, students will not have the benefit of a graph. They will need to rely on a table or guess and check, as well as their knowledge of starting amount and rate of change, to find the point at which both orchards cost the same.

- **Another Commission Problem**

This problem revisits the *Commission Problem* from Unit 2. Eric and Nancy have both gotten raises from their employers, and they want to figure out how many fish tanks they would each need to sell so that they could bring in the same amount of money in a given month. The difference here is that Nancy has created functions—written in function notation—to calculate their respective incomes. Students will need to know function notation in order to solve this problem. The problem could also be used as an introduction to function notation. Just ask students to read through the first part of the problem, and then go back to talk about how function notation works and what it means.

Core Problem

Choosing a Cell Phone Plan

Bernard is trying to choose a data plan for his smartphone. He narrows his decision down to two providers: PEMDAS Wireless and CCSS Mobile. When he searches online, he sees an advertisement for each of the providers.

- Using the information from the advertisements, complete the tables for both providers.

PEMDAS Wireless	
Gigabytes	Total Cost
0	
1	
2	
3	
4	

CCSS Mobile	
Gigabytes	Total Cost
0	
1	
2	
3	
4	

- Based on the data in the table, which provider would you choose? Why?

- 3 What is the starting amount for PEMDAS Wireless? What is the starting amount for CCSS mobile? What do these numbers mean in the context of the question?

PEMDAS Wireless:

CCSS Mobile:

- 4 What is the rate of change for PEMDAS Wireless? What is the rate of change for CCSS mobile? What do these numbers mean in the context of the question?

PEMDAS Wireless:

CCSS Mobile:

- 5 For each provider, determine a rule that could be used to calculate the total cost for any number of gigabytes used. You should write two different rules.

PEMDAS Wireless:

CCSS Mobile:

- 6 Using your function rules for each provider, complete the tables below. Make sure to calculate carefully! You will be using these tables to graph the functions.

PEMDAS Wireless	
Gigabytes	Total Cost
0	
2	
4	
6	
8	
10	
12	

CCSS Mobile	
Gigabytes	Total Cost
0	
2	
4	
6	
8	
10	
12	

- 7 For each provider, plot the points from the table and connect them. Be sure to label each graph!

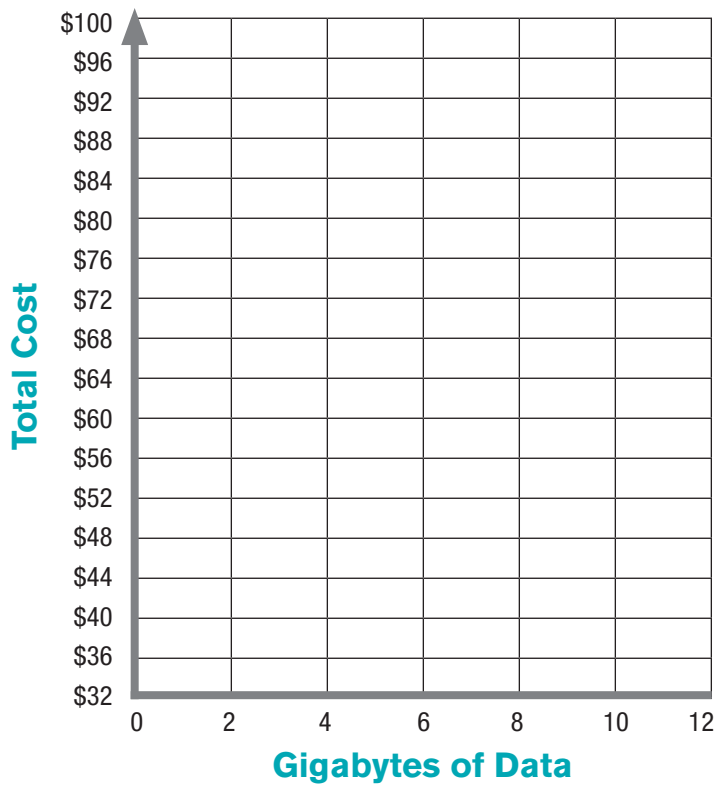

- 8 What is the significance of the point where the two lines intersect?

Supplemental Problem 1

The Price of Math Books

Consumers and businesses are constantly engaged in a tug of war. As consumers, we want to spend as little money as possible, and businesses want to make as much money as possible. It is a balance. Consumer power is the power to not buy—in most cases, a business can't just charge whatever it wants for something. If they charge too much, no one will buy it. A business's power is in its power to choose what to produce or sell. If consumers are not willing to pay enough for them to make a profit, they won't make or sell that product.

Imagine that everyone in your class wants to buy a math book to study for the HSE exam. If the book was priced at \$200.00, would anyone in your class want to buy it? Probably not. What if the book was priced at \$4.00? In this case, almost everyone would be willing to buy a copy. This example shows that when the price of an item is very high, then few people want to buy it.

When the price of the item goes down, more and more people are willing to buy it. So, we can say that the demand for the math book is higher when it is priced at \$4.00 per copy. The demand for the math book is low when it's priced at \$200.00 a copy.

The table to the left gives an example of how many people would want to buy a math book at each different price.

Price of Math Books	Quantity Demanded
\$4	12
\$10	9
\$16	6
\$22	3
\$28	0

- 1 What is the relationship between the price of the math books and the number of books that people would want to buy?
- 2 Notice that in the graph on the next page, the *x-axis* represents **Quantity** and the *y-axis* represents **Price**. Plot each of the five points in the table. Why is the Quantity Demanded graph decreasing?
- 3 How many math books would be demanded by the students in the class if the price was \$14? What if the price was \$8?

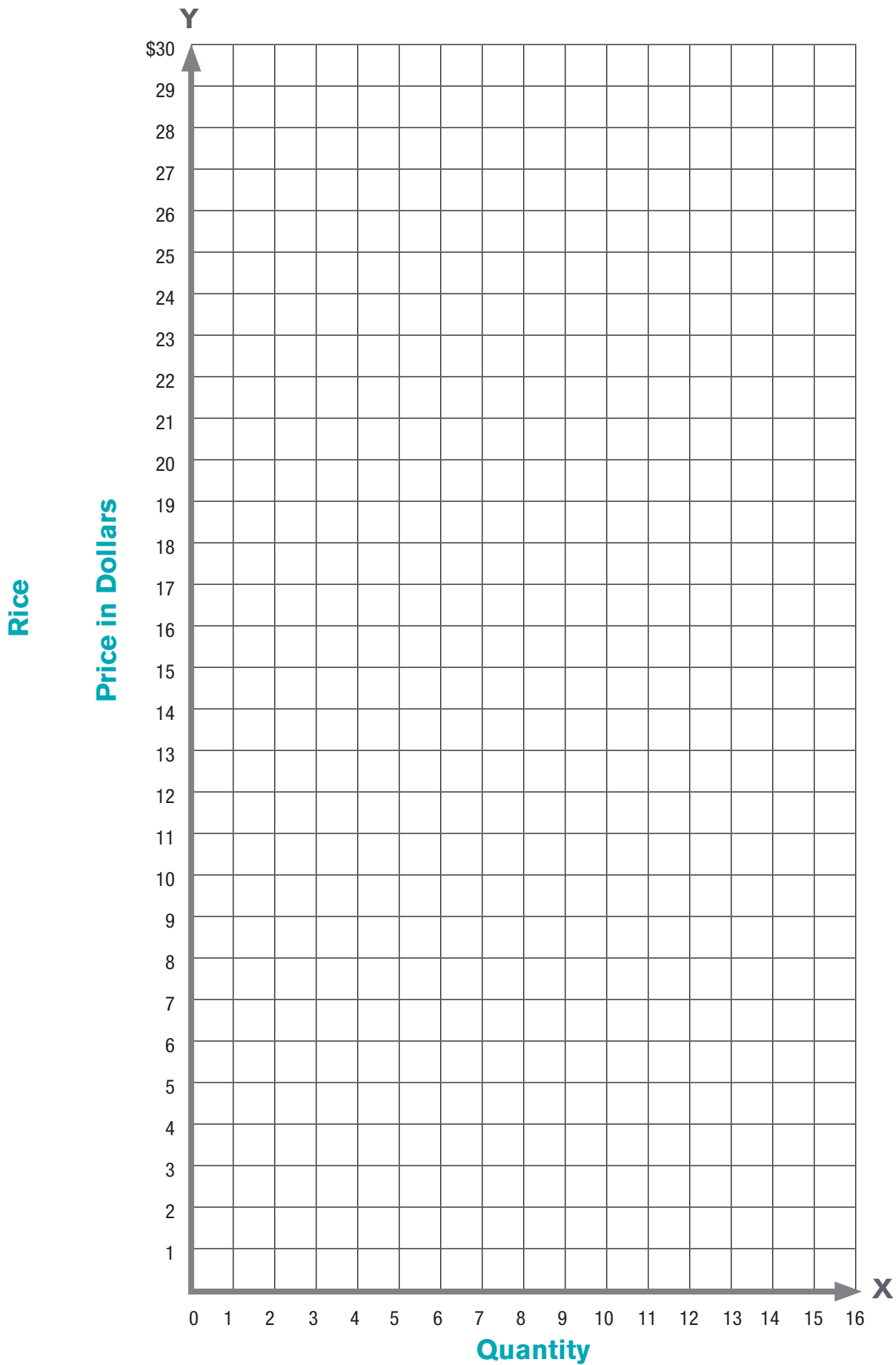

Supply

Price of Math Books	Quantity Supplied
\$8	1
\$10	3
\$12	5
\$15	8
\$20	13

Now let's think about supply. Supply refers to how many items a company would want to produce.

If you were a publishing company, you would not want to use your resources producing books if you weren't going to be able to charge enough to make a profit, especially since producing the books costs money. But if you knew that you people would be willing to spend \$28 or more on books, you would want to produce a lot of them because you could make more money.

This table to the left shows how many books a publisher would want to supply at a bookstore for several different prices.

- 1 What is the relationship between the price of math books and the quantity that the publisher would want to supply?
- 2 On the same sheet of graph paper that you used for demand, plot the five points and connect them. How would you describe the shape of the *Quantity Supplied* graph?
- 3 How is the supply graph similar to/different from the graph for demand?
- 4 Look carefully at your two graphs. The publisher needs to determine how many books to supply and how much they should cost. Based on your graphs of supply and demand, help them make a final decision.

A graph of supply and demand is useful because it represents a balancing point between what consumers want and what companies are able to produce. In economics, this balancing point is called **equilibrium**.

Quantity to supply:

Cost:

Supplemental Problem 2

Picking Apples

Anna and Chris want to pick apples. They find two orchards right next to each other; David's orchard and Pam's orchard.

The signs below are at the entrance to the orchards:



- 1 Anna wants to pick 6 pounds of apples.
 - a. How much does this cost at David's Orchard? _____
Show your calculations.

 - b. How much does it cost at Pam's Orchard? _____
Show your calculations.

- 2 Chris has \$30 to spend.
 - a. How many pounds of apples will he get if he goes to David's Orchard? _____ Explain how you figured it out.

 - b. If Chris goes to Pam's Orchard, how many pounds of apples will he get? _____ Explain how you figured it out.

- 3 Which orchard is a better deal? Be prepared to explain your reasons to someone who disagrees with you.
- 4 One student says that apples are cheaper at David's orchard, and another student says that they are cheaper at Pam's. Can both of these statements be correct? Why?

Supplemental Problem 3

Another Commission Problem

This version is a sequel to the Commission Problem in Unit 3: Three Views of a Function.

Eric and Nancy both had a successful year selling fish tanks for their respective employers, and so they were both given raises.

Eric: Eric's base salary is still \$1400, but now he makes a commission of \$100 for each fish tank that he sells.

Nancy: Nancy now gets a base salary of \$500 per month, but her commission has stayed the same at \$250 per fish tank.

Eric and Nancy still want to make sure that they contribute the same amount to their total monthly income, and Nancy proposes using algebra to figure out how many fish tanks that they would each need to sell. She tells Eric that he can calculate his monthly income by using the formula $f(x) = 100x + 1400$. She says that she can calculate her own salary by using the function $g(x) = 250x + 500$.

- 1 What does the variable x represent in Nancy's formulas?
How do you know?
- 2 Who makes more if they each sell 4 fish tanks? Show all your work.
- 3 Who makes more if they each sell 8 fish tanks? Again, show all your work.
- 4 How many fish tanks would each person need to sell so that they made the same amount of money?

**Good instruction spirals
backwards and forwards,
reinforcing new ideas and
building off of old ones.**

UNIT 5

Nonlinear Functions

Up until now, the problems in this curriculum framework have focused on linear relationships and functions, and students have explored these relationships through tables, rules, and graphs. In this unit, we introduce the concept of nonlinear functions. The core problem in this unit, the *Job Offer Problem*, will help students to see how the graph of a quadratic or polynomial function differs from the graph of a linear function, and they will develop a more nuanced understanding of rate of change. Students will also work with quadratic functions that model real-world applications to physics.

SKILLS DEVELOPED

- Using charts, tables, drawings, and graphs to analyze nonlinear change.
- Graphing quadratic functions and relating them to function tables.
- Generating outputs from a rule written in function notation.
- Understanding constraints on the domain (possible inputs) of a function given a particular context.
- Seeing and recognizing the difference between the graphs of quadratic and cubic functions.
- Applying quadratic function rules in specific problem-solving contexts.

KEY VOCABULARY

nonlinear function: a function in which the variable is raised to the power of 2 or higher. The graph of a nonlinear function forms a curve.

parabola: the shape formed by the graph of a quadratic function. Parabolas are U-shaped and can open either upward or downward.

polynomial function: a mathematical expression with two or more terms. Often, polynomial functions are written as the sum or difference of several terms in which the same variable is raised to different powers.

quadratic function: a polynomial function in which the variable is raised to the power of 2, but not higher. The graph of a quadratic function forms a parabola.

cubic function: a polynomial function in which the variable is raised to the power of 3.

Core Problem Overview: The Job Offer Problem

The *Job Offer Problem* asks students to use math to help them make a decision. They have to choose between two job offers based on each company’s plan for calculating raises. Using math to make and justify financial decisions is an important life skill—one that is especially emphasized in Unit 4, as well as other units in this curriculum framework.

The problem begins by asking students to think about both offers, without doing much, if any, math. They should consider the offers as they are presented and

write about why they would choose one job offer over the other. At this stage in the problem, it is important that students understand exactly how the raise plan works at Big Time Publishing. At BTPC, Rachel’s hourly wage will be \$0.50 more than it was the year before. This means that after the first year, she will get a raise of \$0.50 an hour. After two years, she will receive a raise of \$1.00 an hour, and after three years she will get a \$1.50/per hour raise. The pattern continues, with the amount of Rachel’s raise increasing after each additional year she works for the company. The raise schedule at Nadir Books is linear—that is, Rachel will always receive a raise of \$1.50 per hour for each year that she works for the company. At this stage in the activity, your role is to help students understand how the different raises work. You don’t need to help them calculate her hourly wage in a given year. Just get them thinking about how the raises work so that they can make a decision about which job they would choose.

The problem includes scaffolding in the form of a table to help students answer question number 2. Depending on the level of your class, you may choose to remove this scaffold and ask them to solve the problem in any way they see fit. One benefit of using the table is that it helps students to draw the graphs for Rachel’s salary at Big Time versus Nadir Books, which is the next step in the problem. The main goal of the *Job Offer Problem* is to help students see what nonlinear growth looks like when graphed, and so this is a key step in the problem. Once students have completed the table and finished drawing their graphs,

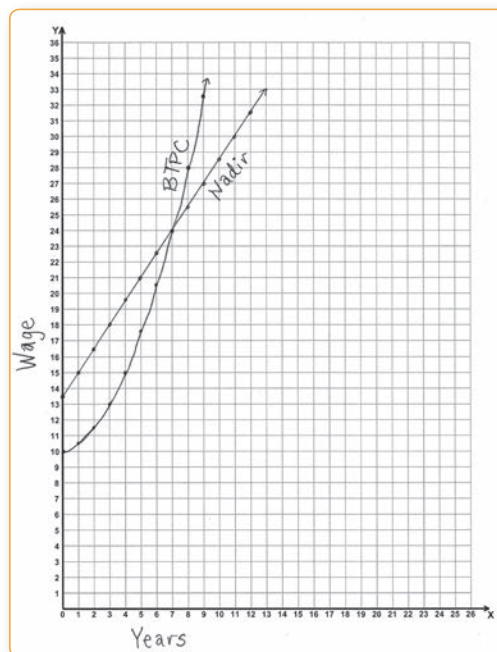

it would be a good idea to spend time talking about the similarities and differences in the graphs. For example, both represent an increase, but the rate of increase for Big Time Publishing Company changes each year, which results in a curve.

The last part of the problem asks students if they would still choose the same offer as they did in the first part. Here, students should have a conversation about why they would stick with their choice or why they might change it. For example, a student who had initially chosen Nadir Books as the better offer might switch to Big Time Publishing, pointing out that it would pay off eventually if she worked at Big Time for several years. Others might point out that it is risky to plan ten or fifteen years ahead when taking a job because of the economy or changes in consumer demand. All of this is rich territory for you to explore with your class, and it helps students see how math can be used in decision-making.

TEACHING THE CORE PROBLEM

After students have had time to read the first part of the problem, you should help them to clarify exactly how the raises work at both companies. You might begin by asking some questions like:

- *Let's start by talking about the offer at Big Time. Can someone explain to me how the raises work at this company?*
- *How big of a raise does Rachel get after one year at Big Time? After two years? After four years?*
- *How much of a raise would Rachel get at Nadir Books after one year? After two years? After four years?*

Once students understand how the raises work, ask them to take a few minutes and decide which job they would want to take. You could then ask students to discuss their choice with a partner, or you could ask the class to vote and record their responses on the board.

Next, you should give the students time to work individually on the second part of the problem. While they are working, make sure to circulate around the room and observe each student's work. Their table for Big Time Publishing should reflect the whole-class discussion that took place earlier. If you find that a student is having trouble calculating Rachel's correct wage for a given year, you can ask questions like:

- *Talk to me about the wages for Big Time in your table. How did you calculate those?*
- *Let's read the prompt together. For each year at Big Time, Rachel's raise will be \$0.50 more than it was the year before. What does that mean?*

- *Let's think about the discussion we had earlier. We said that Rachel's raise would get bigger every year at Big Time. Does your table show this?*

After students complete the table for Big Time, they may have trouble seeing that the raise for Nadir is the same year after year. If you notice students making mistakes on this part of the table, you can use a similar line of questioning or ask them about the rate of change.

You'll notice that the axes on the graph paper are not labeled, and you may need to help your students identify which axis should be used to represent years (the x -axis) and which should be used to represent Rachel's wage (the y -axis). It might help them to ask which column in the table represents the inputs (the years) and which represents the outputs (the hourly wages) in this situation. If students are really struggling as a result of the two columns of outputs, you can have them re-write the table as two different tables—one for BTPC and one for Nadir Books. Ultimately, your students should recognize that the graphs should be increasing as they move from left to right, and this might help them to realize how to label the axes. If they label the axes incorrectly and start to draw graphs that are decreasing, you can talk to students about making sure that what's happening in the graph reflects what's happening in the table—that is, if wages are going up on the table, the graphs should be going up as well.

When students finish the graphing part of the activity, have them talk about the differences in the graphs. Some questions you might ask them to consider are:

- *What is similar about these two graphs? What is different?*
- *What do you notice about how the graph of Rachel's wages at Big Time changes over time?*
- *Does this make you want to change your vote from the first part of the problem? Why?*
- *What do you think would happen to the graphs after the ten years shown on the table? Can you extend them on the graph paper?*

If some students finish early, you could give them calculators and ask them to solve an extension question. You could use the following questions:

- *Let's say Rachel would be paid for 35 hours per week, for 50 weeks a year. How much would she make at each company in the first year after she was hired?*
- Some students might even notice that, while she would make more during her seventh year at Big Time, she also would be

making less each year for the six years before that. In this case, you could ask, *Rachel knows that she wants to choose a job and stick with it for ten years. How much in total earnings would she make after ten years at Big Time? How much would she make at Nadir?*

- You might also ask students to think about how long Rachel would have to work at Big Time to make her choice really pay off: *If Rachel worked 35 hours a week for 50 weeks a year, how many years before her total earnings at BTPC were more than her total earnings at Nadir Books?*

These extensions are by no means exhaustive, but they help students to think further about the idea of choosing a job.

PROCESSING THE PROBLEM

Because the goal of this problem is for students to see the difference in a graph that grows linearly and one that grows quadratically, there is not a lot of room for multiple solution strategies. Your main goal in talking about this problem with the class will be to address the shapes of the two graphs. But first, it would be a good idea to discuss question number 4 as a group. You might start by asking how many people changed their mind about which offer they would accept. Some questions to get the discussion started are:

- *How many people changed their vote? And if you changed it, what made you decide to change? If you don't want to change your vote, why not?*
- *Do we all agree on which company gave Rachel the better offer? Why do you think we disagree?*

After each student has had a chance to contribute to the discussion, tell the group that you want to talk about the shapes of the graphs. You should let the students talk about all the things that the graph have in common and all of the ways that they are different. You might write a dividing line through the middle of the whiteboard and list the similarities on the left and the differences on the right. The main similarity is that both graphs represent an increasing wage, but there are a number of differences that could come up in the discussion. For example, one of the graphs is a curve while the other is a line; the two graphs start at different points on the y-axis; and the graph of Big Time increases slowly at first but then gets steeper and steeper, while the graph of Nadir increases at the same rate.

Now you can ask some specific questions about the graphs. Some suggestions for the whole-class discussion are:

- *What were some of the things you noticed from the graph?*
- *During the first few years, which graph increases the most rapidly?*
- *During which year do the graphs increase at the same rate?*
- *When does the graph of Big Time start to grow more rapidly than the graph of Nadir?*
- *What will happen if we continue the graph for Nadir Books?
What will happen if we continue the graph for Big Time?
How do you know?*
- *How does the graph help support your decision of which offer to take?*

When you feel like your students have a good understanding of the difference between the linear and quadratic graph, talk to your students about some of the vocabulary you will be using to talk about graphs like this one. You could introduce the terms *nonlinear* and *parabola* and explain that students will be seeing them again in the supplemental problems and on the HSE exam.

SUPPLEMENTAL PROBLEMS

The supplemental problems in this unit invite further investigation into the graphs of nonlinear functions. I would recommend doing these problems in the order that they are presented here, though each of these should be accessible to students who have worked on the *Job Offer Problem*.

- **The Nebraska Rainfall Problem**

This problem asks students to take information from a table, put it onto a graph, and draw conclusions about rainfall levels based on the shape of the graph. Initially, the graph increases at a quadratic rate. It then levels off, which indicates that no significant rainfall occurred during that period. Then at the end of the year, the graph increases at a linear rate. Students will plot the points carefully and answer questions about the changes in rainfall from month to month. The problem also asks them to tell the story of how hard the rain fell throughout the year. In teaching this problem, you would want them to see that the rain fell at an increasingly heavy rate in the first half of the year, then there was no rainfall, and then the rain fell at a constant rate at the end of the year. We have included a graph that shows Yearly Precipitation alongside Monthly Precipitation. You might distribute these to your students after they have completed the activity so that you can talk about the relationship between the graphs.

■ Gravity and a Dropped Ball

This supplemental problem introduces algebraic notation to illustrate that the velocity of a dropped object will increase the longer it falls. The goal of this problem is to build some background knowledge in physics and help them get familiar with evaluating quadratic functions on the TI-30XS Multiview calculator. Students will begin by completing a chart that shows the dropped ball's position after a given number of seconds. They will see the ball falls faster and faster over time. The last question here is tricky: By plugging 10 and 11 seconds into the formula, they will see that the ball hits the ground before 11 seconds elapse, but they may need some guidance about how to solve for the exact value. When using this problem initially, it might be good enough to help students approximate the time it would take for the ball to hit the ground. Some students may be able to come to an approximate answer by recognizing and continuing patterns in the table.

■ The Graphs of $y = x^2$ and $y = x^3$

In order to be successful on the HSE exam, your students will need to be able to distinguish between different kinds of nonlinear graphs. This simple activity builds upon the function machines and graphing activities from the previous units by asking students to complete an input/output table and then draw a simple quadratic and cubic graph. If you've had the chance to work with your students on signed numbers, they should be able to complete the tables without the aid of a calculator. But this can also be a good place to help students develop fluency with the TI-30XS Multiview calculator. After your students have completed each table and drawn the graphs, it would be worthwhile to talk to them about how the shapes of the graphs are similar and how they are different. You can also ask students what patterns they see in the tables (for one, there is no constant rate of change in the outputs).

*Core Problem***The Job Offer Problem**

Rachel is unhappy at her job, and so she has started interviewing with other employers in her industry, hoping that she can start to make more money in the long run. When she met with Big Time Publishing Company (BTPC), the manager told her that her starting wage will be \$10.00 per hour and that she will receive a \$0.50 raise after the first year. For each year that she stays with the company after that, her raise will be \$0.50 more than it was the year before.

After her interview with Big Time Publishing Company, she met with Nadir Books and told the manager about the offer she was given. The manager assured Rachel that her offer will be better. She offered Rachel a starting wage of \$13.50 per hour, with a raise of \$1.50 each year.

- 1 Consider both offers. If you were in Rachel's shoes, which offer would you accept? Explain the reasons for your choice.
- 2 Complete the table below for each job offer. In which year will Rachel make the same hourly wage no matter which job she chooses?

Year	Hourly Wage at Big Time Publishing	Hourly Wage at Nadir Books
0 (newly hired)		
1		
2		
3		
4		
5		
6		
7		
8		
9		
10		

- 3 On graph paper, plot the points for the graph of Big Time Publishing Company's salary offer, and then connect them. Next, plot the points of Nadir Books's offer on the same graph and connect them. What do you notice about the two graphs?
- 4 What are the coordinates of the point where the two lines intersect? What does this point represent in the context of the problem?
- 5 Would you still choose the same job offer as you did before? Explain the what circumstances might make you choose the job at Big Time Publishing. Explain what circumstances might make you choose Nadir Books.

Supplemental Problem 1

The Nebraska Rainfall Problem

Rainfall is very important to farmers in the Western United States since crops like wheat, corn, or soybeans need rain water to survive. A farming family in Western Nebraska recorded the amount of rainfall on their land over a period of one year beginning in January. They kept track of the amount of rainfall that fell each month (**Monthly Precipitation**) in order to find out how much rain had fallen so far that year (**Yearly Precipitation**).

The family needs help calculating the Yearly Precipitation. For each month, calculate how much rain had fallen so far that year.

Month	Monthly Precipitation (in inches)	Yearly Precipitation (in inches)
January	0.5	
February	1.0	
March	1.5	
April	2.0	
May	2.5	
June	3.0	
July	0.0	
August	0.0	
September	1.0	
October	1.0	
November	1.0	
December	1.0	

Using the x -axis for months (1 for January, 2 for February, and so on) and the y -axis for total rainfall, construct a graph that shows Yearly Precipitation. You should plot 12 points and connect them.

- 1 In which months did the total amount of rainfall grow at a linear rate? How can you tell?

- 2 In which months did the total amount of rainfall grow at a quadratic/nonlinear rate? How can you tell?

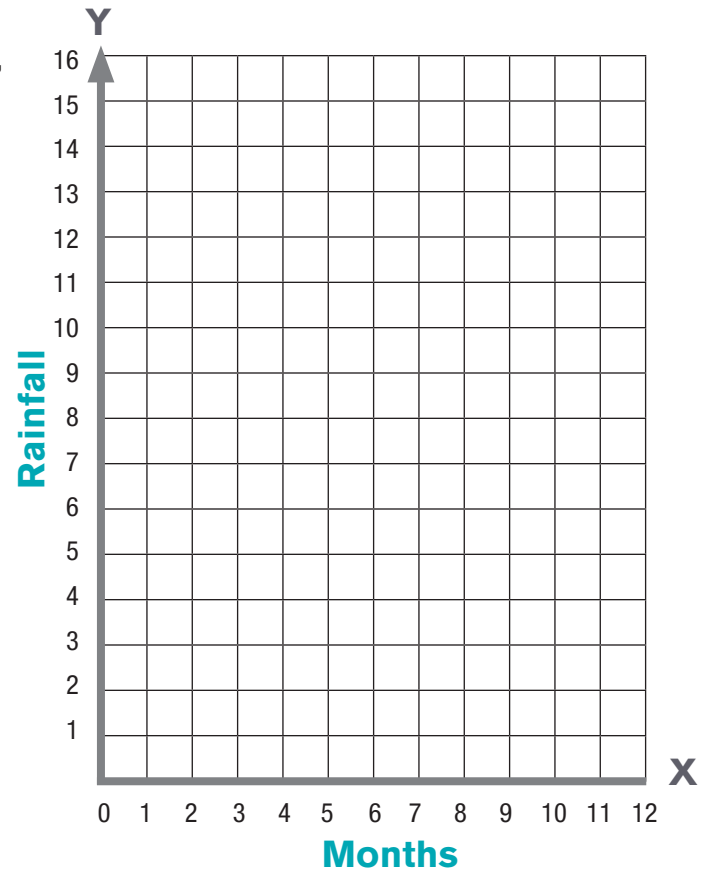

- 3 Use the table and your graph to tell the story about the rate at which the rain fell in Western Nebraska during this year. As specifically as you can, you should discuss the changes in rainfall—and in the shape of the graph—over the course of the year.

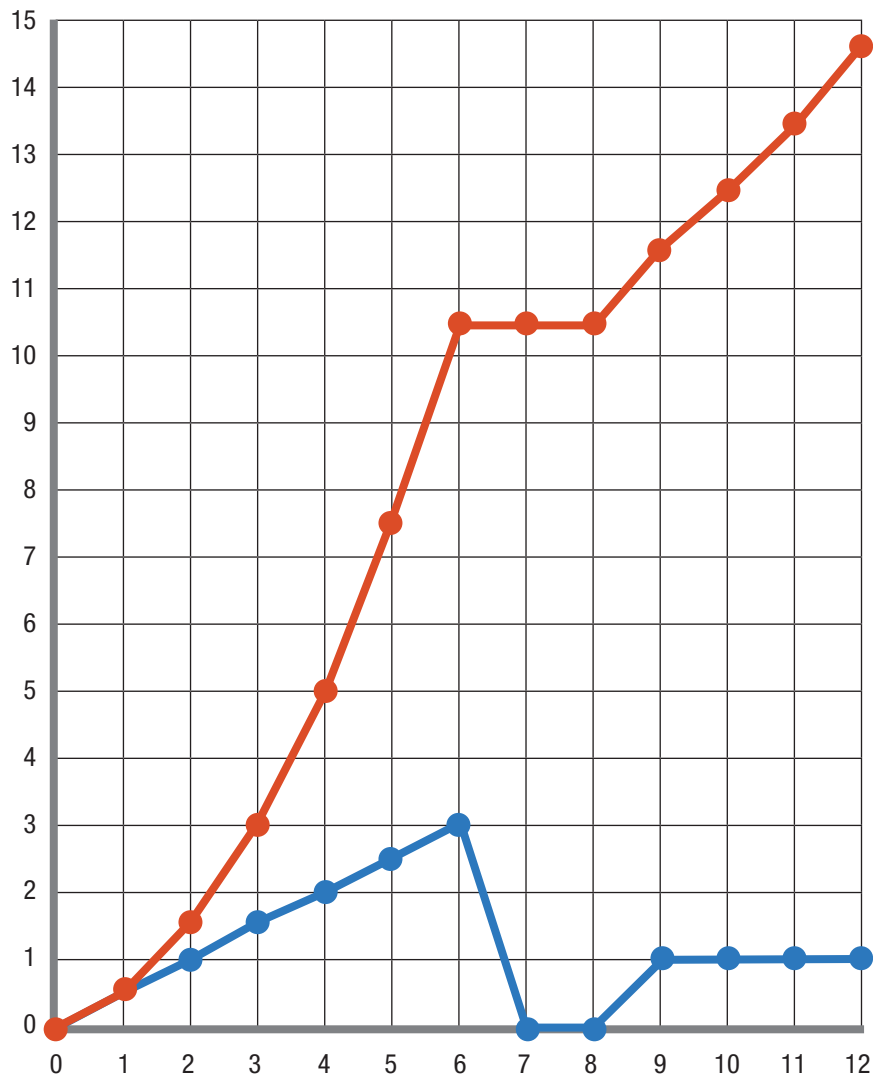

Supplemental Problem 2

Gravity and a Dropped Ball

When an object is dropped, gravity pulls it down toward the earth. To calculate the distance travelled by a falling object, we use the equation:

$$d = \frac{1}{2}gt^2$$

In this equation, the variable d represents the distance travelled by the object, g represents the acceleration due to gravity in meters per second squared, and t represents the time in seconds. On earth, the acceleration due to gravity is 9.81 meters per second squared. This never changes.

You go to the top of One World Trade Center, which is 546 meters tall, and drop a baseball from the top.

- 1 How long do you think it would take to hit the ground? Write your best guess.
- 2 Using the function equation above, complete the table below to find how far the ball will have fallen after a certain amount of time has elapsed.

Time (in seconds) t	Distance the ball has fallen (in meters) d
1	
2	
3	
4	
5	
6	
7	
8	

*Supplemental Problem 3***The Graphs of x^2 and x^3**

Complete the input/output tables below, then graph each function on the coordinate plane.

$f(x) = x^2$	
Input x	Output $f(x)$
-4	
-3	
-2	
-1	
0	
1	
2	
3	
4	
	25

$f(x) = x^3$	
Input x	Output $f(x)$
-3	
-2	
-1	
0	
1	
2	
3	

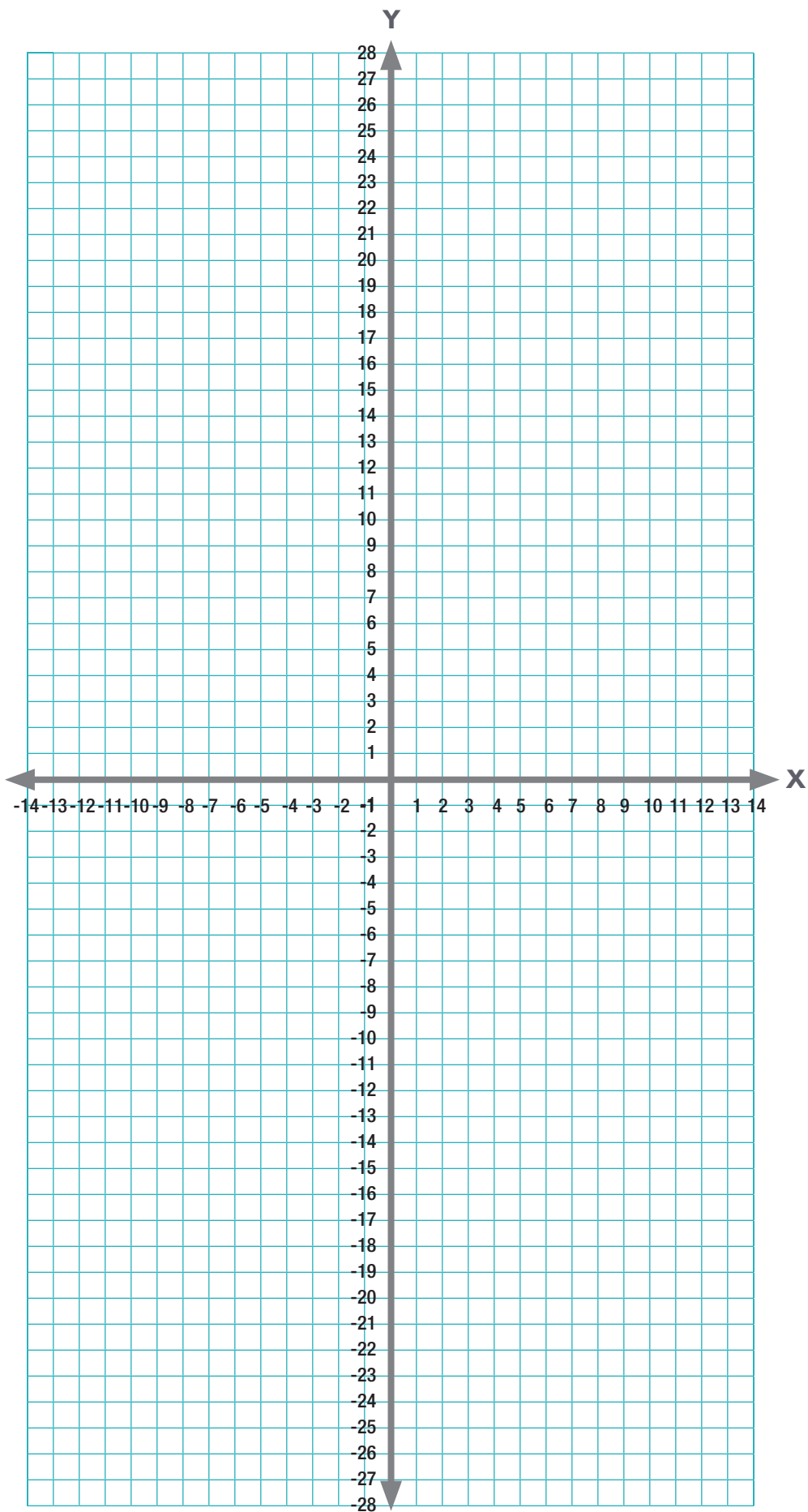

UNIT 6

Modeling Exponential Growth

Now that students have had a chance to explore functions that grow at linear and quadratic rates, they have all the tools to analyze exponential growth and decay. You can introduce this concept to your students through the *Growth of a Smartphone App* problem, which offers an easy-to-understand model of how quickly things grow when they grow exponentially. The goal for this unit is for students to understand the difference between linear, quadratic, and exponential growth, and to know when each kind of growth applies to a given situation. At the end of the unit, students should also be able to understand and solve exponential growth problems as they appear on the HSE exam.

SKILLS DEVELOPED

- Using tables, charts, and drawings to model exponential growth.
- Seeing exponential growth models in word problems.
- Distinguishing between situations that can be modeled with linear and exponential functions.
- Observing that a quantity increasing exponentially will eventually exceed a quantity increasing linearly or as a polynomial function.
- Noticing that in exponential functions, the variable is in the exponent position, and interpreting equations accordingly.

KEY VOCABULARY

exponential growth: growth whose rate becomes increasingly rapid in proportion to a growing total number. In other words, a quantity may grow slowly at first, but it will eventually begin to grow at a rapid rate. Some applications of exponential growth include calculating compound interest or population growth. In exponential growth problems on the HSE exam, the variable—or input—is in the exponent position.

exponential decay: a decrease whose rate is proportional to the size of the population. Exponential decay can be thought of as the opposite of exponential growth, i.e., the quantity will decrease rapidly at first, but will eventually decrease at a smaller and smaller rate as the size of the quantity becomes smaller. Exponential decay is commonly applied in analyses of half-life of radioactive substances.

growth/decay factor: the constant factor by which a quantity multiplies itself over time. In mathematical functions, the growth factor is usually modeled by $1 +$ (percent of growth expressed as a decimal). For example, in the supplemental problem *Observing a Mouse Population* (below), the population is increasing annually by 8%. We see the population growth factor written in the formula as (1.08) . The decay factor is similar. It is modeled by $1 -$ (percent of decay expressed as a decimal).

Core Problem Overview: Growth of a Smartphone App

This problem asks students to consider how many users will download a new Smartphone app given a specific rate of growth. Zach, the developer, creates the app and tells two friends about it. Those two friends download the app, and then each of them tells two of their friends about the app. These four friends also download the app, and then each of them tells two new friends. The pattern continues for one week. Through working on the problem, students should see that the number of downloads doubles each day, which models a simple form of exponential growth.

This activity starts with students making a prediction about the total number of downloads for the week. Students will usually predict a fairly small number of downloads given the fact that only two people downloaded it on the first day. If you have spent some time on linear growth, they may try to apply a linear growth model in their prediction, which will give them a small number of downloads. The goal of this part of the activity is to get students thinking about the situation, and to get them in the habit of making predictions before they start working with the numbers. Before moving on to the second part of the problem, ask your students to talk about their predictions with the whole class. You might make note of the highest and lowest predictions, and record them on the board so that the class can analyze how close their answer was to the class's high and low predictions.

Now students should pick up their pencils and begin working on the problem. You should provide support by helping students settle on an appropriate strategy for solving the problem. What students should eventually see, through drawing a picture or making a table, is that the

number of people who download the app doubles each day, or, in other words, that the rate of growth increases each day.

As the sample of student work shows, drawing a picture is an excellent way of understanding the pattern, but it is ultimately an unsustainable way of solving the problem. That is, students would need to draw so many hash marks or stick figures that their picture would take a long time to draw and wouldn't fit on a single sheet of paper. We recommend allowing students to come to this conclusion on their own. It will be more meaningful if students try it as a strategy and then realize they will need to do something

Student Work

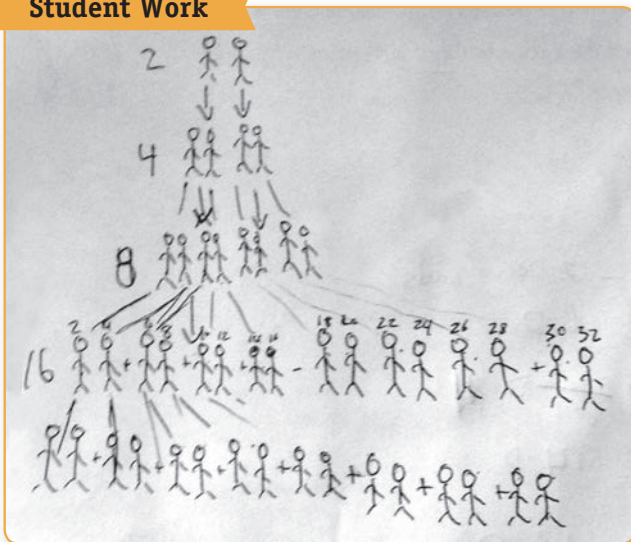

different in order to count all the downloads. Let them come to it, but make sure to make it explicit by asking them to talk about how they started, how/why their strategy shifted, and how their initial strategy helped inform their shift. Students will also need to understand that the problem requires them to add up the number of downloads each day in order to get the total for the week, which is 254 (excluding Zach).

Teaching the Core Problem

To begin the activity, you should ask students to put their pencils down and read through the scenario. Give students about five minutes to think about it, still with their pencils down, and ask volunteers (or each student) to provide a guess. You should record all of their predictions on chart paper or on the board so that the class can see all of the predictions together. Next, ask students which is the highest guess and which is the lowest, and make note of these. At this point, allow students to talk as a whole class about the predictions. You might ask some students to explain their guess, and then, based on these responses, ask if anyone would like to change their prediction.

Now, students should begin working on the second question. The teacher should let students work for a short time before intervening and asking questions. One common mistake that students make is to think that two new people download the app each day, which results in a total of 14 downloads at the end of the week. Another mistake is to think that two more people download the app each day, rather than twice as many. It's okay to let students make these mistake at first! This gives you the chance to talk to them about how they arrived at their answer and help them to see that the number of people who download the app doubles each day, rather than increases by two. To help them see this, you might ask if there is a way they could draw a picture that models the situation. If students are having trouble seeing this, you might also help them to see it by using people in the classroom. Some questions and prompts you could use are:

- *Let's say that you developed the app. Which students did you tell about it on the first day? On the next day, which other students did those two students tell? What do you notice about the pattern?*
- *I noticed you were drawing a picture but then you stopped. Why did you stop here? Did you notice a pattern before you stopped drawing? How could you keep the pattern going without drawing pictures?*
- *How could you organize all this information? Let's pick a day of the week when Zach told the first two people.*

It's important to note that guess-and-check won't work as a solution strategy for this problem. If students are trying to use this method, try to help them start small—with days 1 and 2—and build a table or chart from there. Once students begin to see the correct growth pattern in their drawing or chart, ask them to tell you more about it. Your goal is for them to see that the number of people who download the app doubles each day.

To get the correct answer, students will need to take all of the downloads from each day and add them up. Many students will stop at 128 downloads and forget to find the total for the week. You should ask them to talk about their answer of 128; specifically, does the 128 include all of the people who downloaded it on the other days? Here, some students will include Zach in their total and others won't. Rather than telling students that they should or should not include Zach, ask them to tell you more about it. This is something to discuss during the processing part of the activity.

If students finish early, you might ask them to analyze how the number of downloads would grow if each person who downloaded the app told *three* people rather than two. If your class has spent time working with exponents, you could ask students to look at the number of downloads from each day and think about how they could write those numbers as powers of two. Your students may or may not be able to do this on their own. In any case, you should plan to build this into the discussion after students have discussed their solution strategies.

Processing the Problem

Once all students have had time to work and found the answer on their own, you should lead a whole-class discussion of solution strategies. A good place to start would be to ask the class to look back at their predictions and talk about the differences between those predictions and their actual answer. Some questions for discussion include:

- *How close were our guesses to our actual answer?
Why were we so far off?*
- *How did your thinking change once you started working with the actual numbers?*
- *What is the benefit of making predictions before solving a math problem like this one?*

After you have had a chance to look at the predictions alongside the correct answer, explain to your students that you want to talk about

the different ways of solving the problem. You should select three or four students to present their work on chart paper or on the board. One important aspect of whole-class discussions is to talk about common mistakes. You should find a student who had initially thought that two people downloaded the app each day, and ask them to explain what led them to make that mistake at first and how they corrected it. It would be a good idea to look carefully for different visual representations of the problem and ask students to present those. For example, some students will use hash marks or draw stick figures. You could ask these students to present first and show their work on the board exactly as they had written it on their paper. While they are presenting, ask some of the questions below:

- *Did anyone else try this strategy?*
- *What do you like about solving the problem this way?*
- *He or she stopped drawing after the fourth day. Why do you think he or she did that?*

Some students, like the sample of Ron Lee's work below shows, will draw a sort of tree diagram. If one of your students does this, you might ask them to present next, and ask them to talk about what the lines between each hash mark or stick figure represent.

Other students may have solved the problem correctly without drawing a picture at all, and instead focusing on a chart. You could ask these students to present last and explain how they were able to perform the calculations without a visual aid. At some point in the discussion, students will want to know if Zach should be included in the final tally. There is no correct or incorrect answer here, and one option would be to have your students present a case for why he should be included or not. You could also ask your students to vote on whether or not to include him.

After all students have presented their work, you should take time to focus on the pattern that appears in the tables that students have generated, and help the class to see that the number of downloads on each day is actually a power of 2, as is shown in the table below. If some students have had time to think about this as an extension question, then they could lead the explanation of how each day's downloads can be written as a power of 2. Or, if no students have had time to try this, then you could get them started with days 1 and 2 and ask them to fill in the rest of the table.

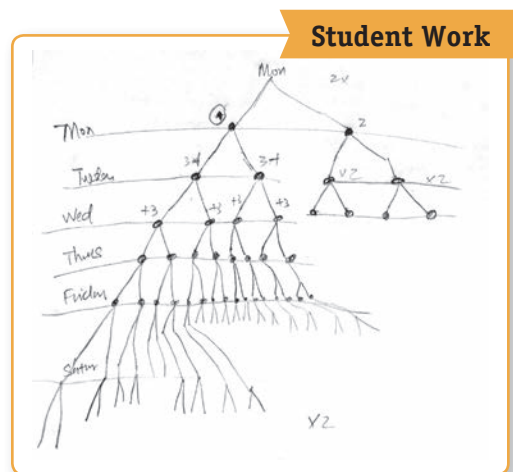

Day	New Downloads On That Day	Written as Exponent
1	2	$2 = 2^1$
2	4	$2 \times 2 = 2^2$
3	8	$2 \times 2 \times 2 = 2^3$
4	16	$2 \times 2 \times 2 \times 2 = 2^4$
5	32	$2 \times 2 \times 2 \times 2 \times 2 = 2^5$
6	64	$2 \times 2 \times 2 \times 2 \times 2 \times 2 = 2^6$
7	128	$2 \times 2 \times 2 \times 2 \times 2 \times 2 \times 2 = 2^7$

Questions for discussion include:

- *In the third column, what is staying the same and what is changing?*
- *Do you see a relationship between the day and the number in the exponent position?*
- *Assuming this pattern continues, how could we find the number of new downloads that would occur on day 12?*
- *In mathematics (and in working with functions), how do we write a quantity that changes like this?*

When you feel like your students have a handle on how we could find the number of downloads on any given day by calculating 2^n , explain to your students that this kind of growth is called exponential. In exponential growth, the variable will always be in the exponent position, and it will often represent units of time.

Supplemental Problems

The supplemental problems in this unit will expose students to other scenarios that ask them to analyze exponential growth and decay. Two of them focus on applications to science, which resemble the types of problems that students might see on the math or science HSE subtests.

■ **The Rice and Chess Problem**

This problem is similar to the core problem in this unit and can be used to reinforce the idea that when a quantity continues to double, it grows rapidly and can produce large numbers.

Because the numbers grow so quickly, students should be given calculators to work on this problem. Before they begin working, though, you might ask them to make a prediction about how many grains of rice the inventor would receive in total before they perform the calculations. In the end, they will find that the inventor would receive more grains of rice than actually exist on Earth!

■ **Choosing Your Salary**

This is another variation on the Rice and Chess problem that asks students whether they would choose a large salary that increases linearly or a small salary that increases exponentially. The problem underscores the idea that over time, exponential growth will always exceed linear growth. Students should be allowed to use calculators for this problem.

■ **Observing a Mouse Population**

This problem uses an exponential growth formula to model the increasing mouse population on an island. In order to use this problem in class, you need to have covered function notation in one of the previous units. You'll notice that this problem looks more like one that students might see on an HSE exam. The problem exposes students to three views of a function—a rule, a table, and a graph—and it opens the door to talk about science topics like population growth and carrying capacity.

Core Problem

Growth of a Smartphone App

Zach developed a smartphone app. On Monday, he told two of his friends about his app and they downloaded it. The next day, those two friends each told two other friends about the app and they also downloaded it. Assume that this pattern continues, and each new person who downloads the app tells two of their friends about it. Make a prediction about how many people altogether will have downloaded the app by Sunday.

1 Write your prediction in the space below, and write a sentence or two to explain your thinking.

2 Let's see how close our guesses are. Exactly how many people will have downloaded the app after one week?

Supplemental Problem 1

The Rice and Chess Problem

There is a famous legend about the invention of chess that goes like this:

The inventor of the game showed it to a powerful ruler, who loved it so much that he told the inventor to name his reward—whatever he asked for the ruler promised to give him. The inventor said to the ruler: “I don’t want much. I only ask that you give me one grain of rice for the first square on the chessboard, two grains for the next square, four for the next, eight for the next, and so on for all 64 squares.”

The ruler agreed and laughed that the man had asked for such a small reward, but his treasurer—a mathematician—worried that the amount of rice would be more than the ruler could afford.



- 1 Create a table to find how many grains of rice the inventor would be given in total.
- 2 Were the mathematician’s fears justified, or was the emperor correct in thinking that this reward is rather small?

Supplemental Problem 2

Choosing Your Salary

You are offered a job that last for only thirty days, and you get to choose your salary.

OPTION 1: You get \$100 for the first day, \$200 for the second day, \$300 for the third day, and so on for each day of the seven weeks. Each day you are paid \$100 more than you were the day before.

OPTION 2: You get paid only 1 cent for the first day. On the second day, you get paid 2 cents; on the third, you get paid 4 cents, and on the fourth you get paid 8 cents, and so on. Each day you get paid twice as much as you did the day before.

Which option do you choose? Why? *(Be prepared to explain your reasoning and help the class understand your way of thinking.)*

Supplemental Problem 3

Observing a Mouse Population

Over a period of ten years, scientists studied the population of mice living on a remote island in the Atlantic Ocean. They observed 120 mice on the island in the first year of their study, and they determined that they could use the following formula to calculate the population of mice on the island after a given time:

$$f(t) = 120(1.08)^t$$

- 1 Is the mouse population growing or decreasing? How do you know?
- 2 Complete the table below. If your answer is a decimal for any of the inputs, round it up to the nearest whole number.

Year t	Population $f(t)$
0	120
1	
2	
3	
4	
5	
6	
7	
8	
9	

- 3 Based on the data in your table, what can you conclude about the rate of increase in the mouse population? Is the growth constant, or not?

“ Teachers prepared with support questions and extension questions can keep an entire class of “mixed-level” students working on the same problem and engaged in the productive struggle at the heart of each student’s proximal zone of development. ”

UNIT 7 Equality

Rationale

Equality is a fundamental concept in algebra. It is noted through use of an equal sign, represents a relationship of equivalence, and can be conceptualized by the idea of balance. Despite the importance of the equal sign, there is tons of research that shows that students often have serious misconceptions about what the equal sign means. The research has mostly been conducted with elementary through high school students, but using an assessment included in this unit, I have found it is equally true of adult learners.

Many adult education students think the equal sign means “the answer” or “what you get when you do the operation.” Students who think this way tend to answer questions like $12 + 5 = \square + 6$ incorrectly, writing a 17 in the square. Students also get thrown when they see things like $14 = 17 - \square$, because the operation is taking place on the right side of the equation.

This misunderstanding makes sense if you think about students’ prior experiences with the equal sign. They have been seeing equality in arithmetic for years; most of it has looked like $7 \times 8 = \underline{\quad}$ or $25 \times 18 = \underline{\quad}$. Even the use of a calculator can reinforce this misconception—just push the “=” and the answer appears.

This association of the equal sign with “the answer” as opposed to understanding it as signifying balance or equivalence can be especially problematic when students encounter the symbol in algebra. If students understand the equal sign to mean balance, it makes sense to perform the same operations on either side of the equation. Without an understanding of a balance point between the two sides of the equation, the rule, “Whatever you do to one side you have to do to the other,” becomes a disconnected rule that students struggle to memorize and use.

The problems in this unit were chosen to help students understand the meaning of the equal sign. This is not something we can just tell students and expect to fully take root—they have a deeply-seated misconception that won’t be corrected easily. These activities are intended to help draw out students’ intuitive sense for keeping things in balance and connecting that to the formal use and notation of the equal sign.

Students don’t need to know the names or the symbolic representations, but a sense of these properties of equality will help them gain flexibility in understanding balance and equivalence:

- the reflexive property of equality ($a = a$)
- the transitive property of equality (If $a = b$ and $b = c$, then $a = c$)
- the substitution property of equality (if $a = b$, then b can replace a in any expression without changing the value of that expression)
- the addition property of equality (If $a = b$, then $a + c = b + c$)
- the subtraction property of equality (If $a = b$, then $a - c = b - c$)
- the multiplicative property of equality (If $a = b$, then $a \times c = b \times c$)
- the division property of equality (If $a = b$, then $a \div c = b \div c$)

OPPORTUNITIES TO DEVELOP THE FOLLOWING SKILLS

- Developing fluency with the different properties of equality.
- Creating equations with two or more variables to represent relationships between quantities.

KEY VOCABULARY

balance: a state of equilibrium; equal distribution of weight, amount, etc. Have students brainstorm situations when we talk about “balance.”

a balance scale: a device for weighing. When the pans are equivalent in weight, the scale will be level. We can replace objects in the pans with objects of equal weights without changing the balance. We place an object in one pan and standard weights in the other to find what the object weighs.

equivalent: having the same value. For example, 4 quarters and 20 nickels are equivalent. Eight hours is equivalent to 28,800 seconds.

equal sign: a symbol used to show symmetric balance between two values or quantities, one on each side of the equal sign. Can be read as “is equivalent to” or “is the same as”.

Core Problem Overview: Zip Zap Zowie

This problem describes the relationship (in terms of weight) between four kinds of imaginary objects: zips, zaps, zowies, and swooshes. We are told that one zip equals three zaps. Two zaps equals five zowies. Three zowies equals two swooshes. Finally, we are told that a swoosh weighs 60 pounds. This problem is a good way to draw out “working backwards” as a problem-solving strategy. This is the most common path students find to a solution, though it may take many students some time and trial and error before they come to that strategy.

In the end, students should be able to explain how we can tell that each zip weighs 300 pounds, each zap weighs 100 pounds, and each zowie weighs 40 pounds.

A word on the words: It's fine to change the words if you think your students might be thrown by the imaginary words. I like the “zip,” “zap,” “zowie” and “swoosh” for the lightheartedness of students having to say things like, “Well, I know two swooshes weigh 120 pounds and that is equivalent to 3 zowies, but how do I figure out how much a zowie weighs?”

TEACHING THE CORE PROBLEM

Have a few students read the problem aloud while others follow along. Give them time to work on their own—maybe five minutes. Then have them get into groups of three or four, share their thinking so far, and then keep working towards a solution. Students should be given time to struggle with this problem, and you should support any method that the student has chosen.

If students are struggling, suggest that they try to create a visual representation of the situation. They might draw shapes or pictures, or create some other visual model. A great way to support students with this problem is to give them materials to make the situation tactile as well as visual. Offer students stickies (of different colors if possible), index cards, pattern blocks, etc. to let them experiment with different visualizations. To the {direction} you can see an example of a visual model of a group's solution method.



In addition to suggesting students try to make visual representations, you can help students get unstuck by asking 1 or 2 of the following clarifying questions:

- *What do we know?*
- *What does it mean to say “one zip weighs the same as three zaps?”*
- *If one swoosh weighs 60 pounds, how much do two swooshes weigh?*
- *How much do three zowies weigh? How do you know?*
- *How many zaps weigh the same as 2 swooshes and 2 zowies?*

- *Which weighs more, a ____ or a ____? How do you know?* (You can ask students to compare any of the four words).

Students will need some sense of the properties of equality to work on this problem. This is not to say that you should present these properties before you give out this problem. Many of your students either know, or will intuit, the properties they need. Others will need more support, and we should ask questions to help them see useful properties wherever they are in their solution process. As groups are working, walk around and look for opportunities to test understanding. For example, asking *If one swoosh weighs 60 pounds, how much do two swooshes weigh?* or *How much do three zowies weigh? How do you know?* will help students think about the reflexive property of equality. The idea that each swoosh (and zowie, and zap, and zip) weighs the same amount as every other swoosh is important and may not be immediately understood by every student.

You may have a group that finishes the problem early while others are still working. Ask questions of different group members to make sure they can all explain the method. If each member can, you can offer the following extension, which I learned from Patricia Helmuth, an adult education math teacher in New York's Hudson Valley. Ask students to create another situation (with real-life objects or imaginary words) using the same relationships between the elements, but where $d \neq 60$.

$$a = 3b$$

$$2b = 5c$$

$$3c = 2d$$

Note: Students will probably not solve this problem by setting up equations. That is something that we will draw out of the debrief on their work. Given that, it's best not to use equations in the phrasing of the extension.

PROCESSING THE PROBLEM

As you are walking around and asking the groups clarifying questions, be on the lookout for two things: (1) moments where groups get stuck and (2) different strategies students use.

When you ask groups to present their work, start with the most visual and concrete methods. Save the group that used an equal sign in their method for last. You probably won't get a group that sets up algebraic equations with variables, but you might have something like:

$$\begin{aligned} \text{zip} &= 3 \text{ zaps} \\ 2 \text{ zaps} &= 5 \text{ zowies} \\ 3 \text{ zowies} &= 2 \text{ swooshes} \end{aligned}$$

Ask each group to prepare to present their reasoning by putting their method on chart paper/newsprint. Ask them to make their method clear so that someone else could understand it without having to ask them any questions. As the groups present their strategies, give the class time to ask questions and make statements of appreciation about each other's methods. If no group uses the equal sign, introduce the notation after all the groups have presented. Either way, ask the rest of the class what they think about the use of the equal sign.

Recommended Extension: To engage them further, you can ask students to use the information in the problem and use the equal sign to show equivalence in other ways.

For example:

$$\begin{aligned} 1 \text{ zap} &= 1 \text{ swoosh and 1 zowie} \\ 1 \text{ zip} &= 5 \text{ swooshes} \end{aligned}$$

How many zowies and swooshes would it take to balance with a zip?

Supplemental Problems

The supplemental problems in this unit continue the work of the core problem, giving students the opportunity to build on the strategies and discoveries they've made.

■ Assessment on Equality

This assessment can give you insight into your students' understanding of the equal sign. I am still always surprised by how many of these students get wrong. It really goes a long way towards understanding the problems they have working with equations.

■ Balancing the Scales

These four problems allow students to explore the concept of equality using balance scales. They come from *Math Matters* (see resource section). Each problem has three scales. Students consider the information in the first two scales to figure out what it would take to balance the third scale. Students will have the opportunity to use the addition/subtraction/multiplication/division and substitution properties of equality.

■ Noah’s Ark

This problem comes from fawnnguyen.com, a great math teaching blog by Fawn Nguyen, a middle school teacher in California. It is similar to the core problem, and the balancing scales problems but it is more complex, with more objects (animals) and more “equations.” I highly recommend offering students tools to make visual representations of the problem. You might even make extra sheets of animals for students to cut out. This is a great problem and a great way to see how students can put together all the strategies they developed working on the other problems in this unit.

■ Fix These Equations

I really like doing this activity, created by Steve Hinds, director of Active Learning in Adult Numeracy (alanproject.org). It helps students practice the order of operations, while strengthening their sense of equations being equivalent. In general, having students evaluate whether equations are true or false is a good way to focus their thinking and see where they are at in their understanding of the equal sign. This activity presents a series of false equations—that is, none of them are true. The goal is for students to experiment with placement of parentheses to make the equations true. This is a nice way to end an exploration of the equal sign, since this problem goes beyond the sense of equivalence and actually uses the formal notation of the equal sign.

Zip Zap Zowie

1 zip weighs as much as 3 zaps.

2 zaps weigh as much as 5 zowies.

3 zowies weigh as much as 2 swooshes.

If one swoosh weighs 60 pounds, how many pounds does a zip weigh?

Equality Assessment

Write the correct answer on the line.

$$9 + 11 = \underline{\quad} + 6$$

$$\underline{\quad} = 17 - 4$$

$$19 + \underline{\quad} = 21 + 4$$

$$14 - 4 = \underline{\quad} - 3$$

$$45 + 13 = 13 + \underline{\quad}$$

$$\underline{\quad} + 10 = 7 + 9$$

Describe what this symbol = means without using the word “equal.”

Keeping Your Balance

Solve the four balance problems below. In each problem, use the information from the balanced scales A and B to figure out what is needed to balance scale C.

1

Scale A

Scale B

Scale C

2

Scale A

Scale B

Scale C

3

Scale A

Scale B

Scale C

4

Scale A

Scale B

Scale C

Adapted from *Math Matters: Understanding the Math You Teach* by Suzanne Chapin and Art Johnson

Noah's Ark

Mr. Noah wants his Ark to sail along on an even keel. The ark is divided down the middle, and on each deck the animals on the left exactly balance those on the right—all but the third deck.

Can you figure out how many giraffes are needed in place of the question mark so that they (and the lion) will exactly balance the six zebras?

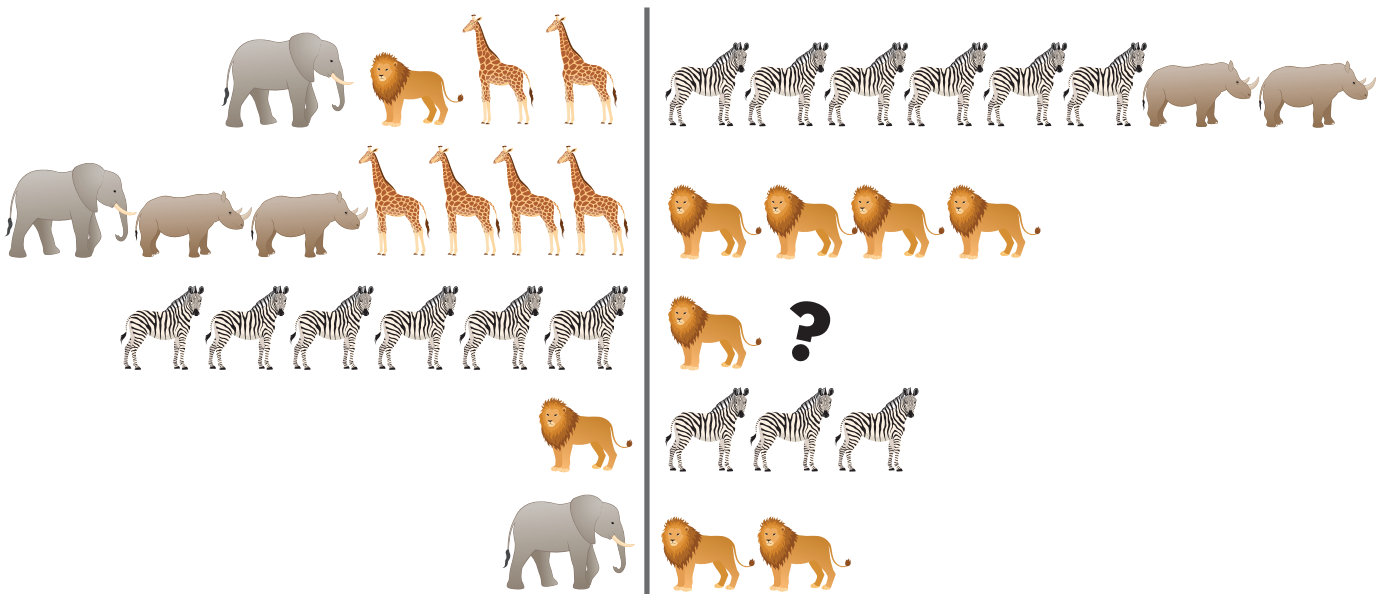

Adapted from fawnnguyen.com

Fix These Equations!

None of the following equations is correct. Insert parentheses so that they are correct.

a. $13 - 2 \times 5 = 55$

b. $12 = 3 \times 6 - 2$

c. $11 - 2 \times 4 + 1 = 1$

d. $11 - 3 \times 4 + 2 = 34$

e. $23 = 3 + 7 \times 2 + 3$

f. $12 - 2 \times 5 + 1 = 60$

g. $4 - 1^2 - 5 = 4$

h. $8 + 2 \times 4 - 1 = 14$

i. $12 - 8 \times 1 + 7 = 32$

j. $8 - 2 + 6 \div 3 = 4$

k. $7 + 3^2 = 100$

l. $24 + 16 \div 8 - 4 = 10$

m. $20 \div 7 - 2 + 5^2 \times 3 = 79$

Solutions to Fix These Equations!

Traditional work with students on the order of operations can be dull. In this format, students must use the order of operations constantly, but it has the advantage of a puzzle-like quality.

- a. $(13 - 2) \times 5 = 55$
- b. $12 = 3 \times (6 - 2)$
- c. $11 - 2 \times (4 + 1) = 1$ (*This one is difficult.*)
- d. $(11 - 3) \times 4 + 2 = 34$
- e. $23 = (3 + 7) \times 2 + 3$
- f. $(12 - 2) \times (5 + 1) = 60$
- g. $(4 - 1)^2 - 5 = 4$ (*If your students haven't worked with exponents, call this one a bonus problem.*)
- h. $8 + 2 \times (4 - 1) = 14$
- i. $(12 - 8) \times (1 + 7) = 32$
- j. $(8 - 2 + 6) \div 3 = 4$
- k. $(7 + 3)^2 = 100$ (*See letter g*)
- l. $(24 + 16) \div (8 - 4) = 10$
- m. $20 \div (7 - 2) + 5^2 \times 3 = 79$

Introduction: More Than Solving for x

What is Algebra?

Before we talk about ways to teach algebra, let's reflect on what algebra is, what it could be, and how it connects to our students and their self-concept.

Here are a few particularly rich definitions:

“Algebra is the fundamental language of mathematics. It enables us to create a mathematical model of a situation, provides the mathematical structure necessary to use the model to solve problems, and links numerical and graphical representations of data. Algebra is the vehicle for condensing large amounts of data into efficient mathematical statements.”

—from *Math Matters: Understanding the Math You Teach*
by Suzanne H. Chapin and Art Johnson

“Algebraic thinking or algebraic reasoning involves forming generalizations from experiences with number and computation, formalizing these ideas with the use of a meaningful symbol system, and exploring the concepts of patterns and functions.”

—from *Elementary and Middle School Mathematics: Teaching Developmentally* by John A. Van de Walle

“Algebra is a tool for making sense of the world—for making predictions and for making inferences about things you cannot measure or count.”

—from “Some Thoughts on Algebra for the Evolving Workforce” by Romberg and Spence (as cited by Manly and Ginsburg, 2010)

Algebra is a way of thinking and reasoning that allows us to create models, study relationships, and solve problems.

WHY DO STUDENTS STRUGGLE WITH ALGEBRA?

When you ask adult education students to define algebra, they tend to give a vague list of disconnected words which somehow relate to procedures for manipulating symbols and equations. They will say

Overview

- What is Algebra?
- Lesson I: Introduction to Patterns and a Scaffolded Approach to Arch Problem
- Lesson II: Open-ended Approach to Pattern #141
- Sample Progression of Visual Patterns
- Additional Recommended Resources

things like “Algebra is x and y ”, or “variables”, or “negative numbers”, or “finding the unknown” without any clear idea of what those things mean or how they are related. These associations are a result of much of algebra instruction, which focuses on developing the procedures to manipulate equations, which is only one facet of the richness of algebra. Compare these impressions with the definitions above.

If you push them further to talk about algebra, many of our students also say things like “Algebra is heartbreak,” or “That’s when I left school,” or “It has nothing to do with real life,” or “Algebra is something that makes me want to give up.” Both categories of answers give us insight into the root of their struggle. As Fosnot and Jacob (2010) stated: *“It is human to seek and build relations. The mind cannot process the multitude of stimuli in our surroundings and make meaning of them without developing a network of relations,”* (as cited in Van de Walle, 2013). When it comes to learning algebra, most adult education students need more than a disparate set of procedures without links to other kinds of math or to anything they can connect with. For most of them it can be like trying to learn shorthand before you learn how to write.

In addition to not having a framework or structure for developing that “network of relations,” students often come to us with incomplete or incorrect prior knowledge of some of the core concepts of algebraic thinking. Variables, patterns, generalizations, equality/balance, and symbolic representations are some of the big ideas in algebraic thinking. Students’ prior understandings of these concepts are the soil in which we plant new ideas, and we need to aim our instruction at these fundamental misconceptions. For example, consider the fact that we use variables in a variety of different ways.

Before reading the next sentence, pause and try to come up with at least three different uses for variables.

One use is in formulas, as in the circumference of a circle can be found using $C = \pi d$. We also use variables to stand for specific unknowns. Students are most familiar with this use—for example $2x + 17 = 63$. We use variables to express generalizations about mathematical relationships and functions, as in $y = 4x + 8$. These are all quite different, and we need to help students differentiate between them by being explicit and by giving students opportunities to reflect on each.

Another common misconception that adult students have about algebra is that it has no connection to the math they already know. This cuts students off from the mathematical foundations they have already built, both in terms of content and in terms of confidence.

What is a Visual Pattern and How Can it Help?

A visual pattern is a sequence of figures that can be used to bridge the gap between what students know and the algebraic reasoning they need to develop.

So how does it work? Let's start with the first four figures in an example of a visual pattern:

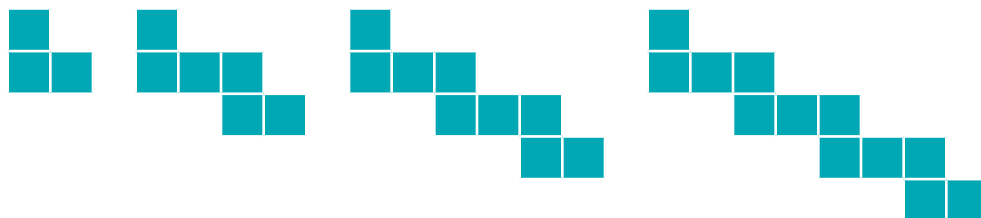

MATH CONTENT YOU CAN TEACH THROUGH VISUAL PATTERNS

- recognizing patterns
- predictions
- organizing data (tables and graphs)
- creating/constructing expressions
- creating/constructing equations
- understanding multiple uses of variables
- constants
- linear equations (like the arch problem)
- matching function equation to a situation
- recursive and explicit rules
- rate of change/slope
- connecting parts of equations to concrete pictures
- starting amount/y-intercept
- graphing (coordinate plane, ordered pairs)
- equivalent functions/expressions
- combining like terms
- evaluating functions
- identifying graph of function (linear and quadratic)
- simplifying expressions
- input/output tables
- independent/dependent variables
- coefficients
- the difference between an expression and an equation
- quadratic equations (like pattern #141 in this unit)
- comparing linear, quadratic, cubic functions
- second differences in quadratic functions
- algebraic notation/function notation
- polynomials
- solving for a specific value of a variable (i.e. Given the number of squares, can you figure out the figure number?)
- order of operations
- skip counting
- area and perimeter
- exponents
- perfect squares
- diagramming/sketching as a problem-solving tool

The list above does not cover all of the math content you can address through visual patterns, but it gives you a sense of the scope and range of what is there. Focusing on an exploration of visual patterns is a nonintimidating way for students to make connections between different algebraic problems and concepts and build up a structure and coherence for understanding how those concepts fit together. Visual patterns are also a great way to introduce algebraic concepts by drawing out a need for them. To put it another way, I'll adapt the words of Dan Meyer (blog.mrmeyer.com): "If algebra is the aspirin, how do you create the headache?" For example, visual patterns allow students to develop statements generalizing patterns they have identified. By having to talk about those generalizations with others, who might have different generalizations, students will be begging to write them as expressions—once you've shown them how. Instead of seeing algebra as something arbitrary and removed, students will begin to see variables and expressions as tools for expressing generalizations efficiently.

You can focus your line of questioning about the pattern to draw out different aspects of algebraic reasoning. For example, you could return to a visual pattern you have explored with one series of questions and then ask another, more complex series of questions. New math content can also be drawn out, depending on the questions you choose. For example, later in this unit you will read a lesson detailing how to use a visual pattern (the arch problem) to create a linear function equation. When returning to the pattern, add a question about how many toothpicks it would take to create a given figure and the task changes to looking for a quadratic function.

Below, you will find some effective questions to use with visual patterns to draw out algebraic thinking and introduce algebraic notation. Please note that you would not want to ask them all at once.

- *How many different patterns do you see?*
- *How do you draw the next two figures?*
- *How do you draw the 10th figure?*
- *How would you draw the 25th figure?*
- *How would you tell someone how to draw any figure?*
- *How could we create a table organizing what we know about the figure numbers and the number of squares in each figure?*
- *If you had a box of 25 squares, what would the figure look like? Would you have any left over?*
- *How would you figure out how many squares are in the 99th figure?*

- *Describe how you would figure out how many squares there are in any figure number.*
- *How many squares would it take to build the n th figure?*
- *(Given a set of expressions) Which expression(s) for the n th figure would work? How does the expression connect to the picture?*
- *Using the picture, describe with words two different ways you could determine the number of tiles needed to make the n th figure in the sequence. Then write a rule or formula that matches each of the ways you described. Define your variables explicitly.*
- *Which figure would have exactly 138 squares?*
- *What is the perimeter of the 10th figure? The 99th figure? The n th figure?*

In the following pages, you will find the following supports for weaving visual patterns into the fabric of your classroom:

LESSON I: Introduction to Visual Patterns & A Scaffolded

Approach to the Arch Problem

This lesson plan begins with some activities to introduce patterns in general. It then models a scaffolded approach to visual patterns with a selection of questions from the list above to build towards the development of linear equation(s) that describe the relationship between the number of squares and the figure number. The lesson goes a little deeper in making explicit how each question can be used to develop specific algebraic content.

- ▶ For additional support refer to the video: **Introducing Patterns and Developing Algebraic Reasoning Through Visual Patterns: A Scaffolded Approach**. Visit the CUNY HSE Curriculum Framework web site at <http://literacy.cuny.edu/hseframework>.

LESSON II: An Open-Ended Exploration of Pattern #141

This lesson plan models an approach to using visual patterns that is more open than Lesson I. As with the arch problem, the activity and questions can be used with almost any visual pattern. Using the open-ended activity described here will not only help students develop their algebraic thinking, but it will give them opportunities to revise and improve their precision in mathematical communication. Since students are creating their own problems and choosing which ones to work on, this activity works especially well with a mixed-level class. Everyone is working from the same visual patterns, but at their own pace.

Pattern #141 is so named because it is the 141st visual pattern on visualpatterns.org. See *Recommended Resources for Visual Patterns* to learn more about this great resource.

Some Suggested Patterns

This is a sample progression of visual patterns that you can do with students over the course of a semester. The patterns in the progression get more complicated, moving from linear to quadratic to exponential growth. If you use this sample progression with your students, you might use the arch problem from Lesson 1 to start, or perhaps between the cross and the factory problems. You might use Visual Pattern #141 between the lobster claw and super columns problems.

Additional Recommended Resources

For teachers interested in learning more about visual patterns and how to bring them into your classroom, we offer some high utility resources for support.

A FINAL WORD ON HOW TO USE VISUAL PATTERNS WITH YOUR STUDENTS

Work on visual patterns regularly in your class. Sometimes that will mean dedicating a whole lesson to them, and sometimes it will mean giving students a visual pattern as a warm-up exercise. You can use the scaffolded approach and the open-ended approach with any visual pattern.

The lessons in this unit offer a model for a scaffolded approach and for a more open approach to working with visual patterns. They are a suggestion of how you might begin and where you might end up. Use the suggested resources and learn more about all the different kinds of activities that have worked for other teachers. Experiment and see what works best with your students. Use the list of “Math Content You Can Teach Through Visual Patterns” as a guide and create lessons targeting that content through visual patterns.

Lesson Plan I: Introduction to Visual Patterns

A Scaffolded Approach to the Arch Problem

OBJECTIVES

By the end of this lesson, students will have an experience with:

- ✓ Looking for and discussing patterns.
- ✓ Using patterns to make predictions and generalizations.
- ✓ Collecting data in a table.
- ✓ Developing strategies to move from concrete to abstract models.
- ✓ Finding recursive and explicit rules.
- ✓ Creating a written description to define a linear function relationship.
- ✓ Creating a linear function equation that matches a situation.
- ✓ Understanding the use of a variable in the context of a function with two unknowns, as opposed to solving for a specific value of x .
- ✓ Seeing a connection between pattern exploration and algebra.

COMMON CORE STANDARDS OF MATHEMATICAL PRACTICE

MP1; MP2; MP3; MP4;
MP5; MP6; MP7; MP8

NOTE TO THE TEACHER

This lesson may take up to three classes depending on the length of your classes.

ACTIVITY 1

Launch: Algebra and Pattern Brainstorm

MATERIALS: Board/Newsprint

STEPS:

- 1 Ask students to take two minutes and write down anything that comes to their mind when they hear the word *Algebra*.
- 2 Bring the class together and ask them to call out their ideas and write them down as students share. You should preface this part of the activity by saying they should not worry about repeating anything or censoring themselves. Students should just say whatever occurs to them. You should also point out that you want to get everyone's ideas, so if they call something out that you miss, they should keep saying it until they see it up on the board. Put

 To see the classroom videos, **Introducing Patterns and Developing Algebraic Reasoning Through Visual Patterns: A Scaffolded Approach**, visit the CUNY HSE Curriculum Framework web site at <http://literacy.cuny.edu/hseframework>.

their answers in two columns. If students say things that have to do with algebra topics, write that on the left. If they say things that have to do with disposition, mindset, emotions, self-concept, record those things on the right. In the end, you'll get something that looks like this:

- | | |
|----------------------------------|-----------------------------------|
| • letters | • a different kind of math |
| • variables | • makes me want to give up |
| • expressions | • when I left school |
| • equations | • confusing |
| • x and y | • college level math |
| • slope | • frustrating |
| • solving for x | • the power when you say "a-ha!" |
| • formulas | • not connected to the real world |
| • finding what's missing | • logical |
| • finding the meaning of letters | |

- 3 Next ask students to take two minutes and talk to the person next to them about what comes to their mind when they hear the word *patterns*—what are they and where do we find them?
- 4 Have students share their ideas and record them on the board. Encourage students to keep sharing and you'll end up with a collection of diverse patterns. Your board may look something like this:

- The things that happen every day (like daily routines)
- Repeated behaviors ("I always date the same kinds of people")
- Like if someone in your family is bald, their children may carry that gene and develop baldness
- Plaid, paisley, quilts (design patterns)
- Music and dance
- Seasons, days of the week

- 5 Suggest to students that it is interesting that one word applies to so many seemingly different situations. What do dancing, repeated behaviors, genetic dispositions, and fashion designs have in common? What is a pattern?

You may get words/comments like: sequences; the way something is supposed to happen; something that repeats itself; something based on past experiences.

- 6** A good way to help students think about this is to talk about the weather. Ask the class if anyone knows what the weather is going to be like over the next few days. Ask, *How can we possibly know what the weather is going to be like tomorrow? Do meteorologists have time machines?*

The concept you want to draw out of the discussion is that patterns are about making observations and collecting information and using that to make predictions. The simplified version behind weather reports is that humanity has been observing the weather patterns in nature for thousands of years and we have learned that when certain things happen, certain other things tend to follow. And we have lots of ways to gather information and we use that information to make predictions, based on what has come before. The idea of making observations and making predictions is an important one, so go back to their brainstorm and see how each pattern they cited in the Pattern brainstorm fits that definition.

ACTIVITY 2 1, 2, 3, 4, 1, 2, 3, 4...

MATERIALS:

- 1, 2, 3, 4 Pattern (handout)
- 1, 2, 3, 4 Pattern—The First 30 Numbers (optional handout)

STEPS:

- 1** Tell the class that we are going to look at patterns as a way to help us understand something about algebra. To begin, write **1, 2, 3, 4** on the board and ask them to predict the next number in the pattern. Most of them will say “5”. Tell them you understand why they would think that, but that you are going to give them a little more information. Write **1, 2, 3** after the **1, 2, 3, 4** you already have written and ask them what the next number will be. Ask them to keep predicting until you have the following sequence on the board:
1, 2, 3, 4, 1, 2, 3, 4, 1, 2...
- 2** Give them the 1, 2, 3, 4 PATTERN handout and ask them to work on the first question on their own for one minute. After a minute have them share their thinking with a partner and work on the problems together.

- 3 As students are working, walk around and look at their strategies. Here are some examples of what you might see:

B Used 4 Times Table

4 th #	4
8 th #	4
12 th #	4
16 th #	4
(20 th #	4)
40 th #	4
80 th #	4
92 nd #	4

C

10th → 2
 20th → 4
 30th → 2
 40th → 4
 50th → 2
 60th → 4
 70th → 2
 80th → 4
 90th → 2
 100th → 4

- A. Find someone who continues the pattern and writes out the sequence.**
- B. Look for any students who recognize that every multiple of 4 will be a 4.**
- "If I know every fourth number is a 4, then I know the 16th, 40th and 92nd numbers will all be 4s. Then I know the 19th will be a 3, the 41st would be a 1 and the 91st would be a 3."*
- C. See if anyone uses the given section of the pattern and just counts moving a pencil from number to number until they get to the 19th, 41st and 91st.**

Look for anyone who continues the pattern to a point, but then starts to find other patterns.

"I started just writing out the pattern and then I noticed that every 10 numbers it goes back and forth between a 2 and a 4."

- 4 When you go over the handout, have someone who continued the pattern and wrote out the sequence until the 19th term to share their strategy.

- 5 Before you talk strategies, take a poll and write all of the answers students got. There may not be agreement on the answers. Having more than one answer on the board allows you to ask students to explain how they got their answers with the goal of convincing someone else of their answer. When you start to discuss the 41st number in the pattern, first ask if we could use the method demonstrated in Step #4 and continued writing out the pattern until we got to the 41st number. Some of them may want to say there are other ways, which you will look at, but make sure you make the point that the first strategy would still work. If someone used multiples of 4, ask them to explain how they used their method to figure out the 41st figure.
- 6 Begin your discussion of the 91st number by taking a poll of answers and writing them on the board. Ask if the previous methods could be used to figure out the 91st number. (They can.) Then ask if someone has another way.
- 7 Optional—If no one continued the sequence and found other patterns, you can give students an opportunity to play around with that idea. Tell students we are going to take another look at a table for this pattern to see if we can use the information to make observations that might help us with our predictions. Give out the 1, 2, 3, 4 PATTERN—THE FIRST 30 NUMBERS handout.

Ask students to take a few minutes and look for any patterns they can find in the numbers that might help make predictions.

Some patterns students might identify:

“If you add 20 to any number in the sequence you will get the same number. For example, the 9th number in the sequence is 1 and the 29th number is also 1. The 3rd number is 3 and the 23rd number is also three, etc.”

“Every 10th number in the sequence is either a 2 or a 4.”

“The 13th number in the sequence is a 1. If you add 4 (and keep adding 4) to the number in the sequence, you’ll keep getting 1. So the 17th number is also 1 and the 21st number and the 25th number, etc.”

ACTIVITY 3

Exploring Visual Patterns—
A Scaffolded Approach

MATERIALS:

- The Arch Problem, part 1 (handout)
- The Arch Problem, part 2 (handout)
- The Arch Problem, part 3 (handout)
- Different color markers

STEPS:

- 1 Write, **Algebra is the generalization of arithmetic** on the board. Ask students what *arithmetic* is. Then ask them what a *generalization* is. Ask students what they think the sentence means.
- 2 Tell students: *In order to help them learn algebra, I want to start working from what you already know. You are going to look at a visual pattern and collect information on how it is changing. Then we are going to work together to use algebra to generalize the patterns we find.*
- 3 Hand out THE ARCH PROBLEM, PART 1, and give students two minutes to look at the pattern and write a few observations down. Then have them talk in pairs about what they see in the Arch Problem. While they are talking, draw the first three figures on the board, large enough to be seen in the back of the room.
- 4 Once your students have had some time to make some observations, bring the class back together and ask them to share the changes they notice in each figure.

Some things they might say:

“The number of squares goes up by 2.”

“The number of squares underneath the top row goes up by 2.”

“As the figure number changes, the figure gets taller by 1.”

- 5 As each student shares one of their observations, stop and ask them to explain so everyone can see it. If, for example, a student says, *“The number of squares goes up by two,”* ask her to point out specifically where she sees that in the drawing. Label the observation on the picture you drew on the board with a color and write the student’s name below, in the same color. After you have recorded a few student observations, the picture might look something like this:

2

This line of discussion is adapted from *A Collection of Math Lessons, Grades 6–8* by Marilyn Burns and Cathy Humphreys.

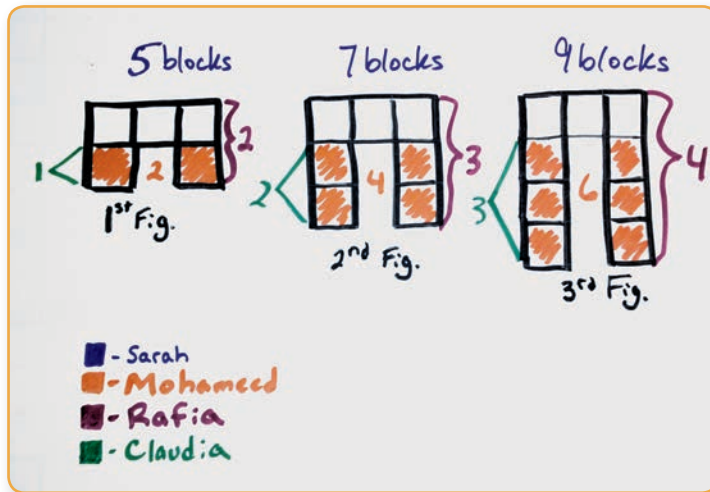

Identifying each student’s contribution is helpful because as you go through the next activity, it allows everyone to talk about certain patterns by name—i.e., “Rafia’s pattern”—instead of having to describe the whole pattern each time someone wants to reference it. Also, since everyone’s heads are full of patterns they want to share, it’s important to make sure everyone is listening to each specific pattern being shared.

- 6 Once all of the observations have been shared, tell the class they are going to use their collective observations to make predictions. Have your class get into groups of 2-3 students and hand out ARCH PROBLEM, PART 2.
- 7 Walk around the room as the groups are working. Listen for interesting discussions, disagreements and struggles to raise during the whole class discussion. As you walk around, keep in mind the things you want to come out of the discussion for each question (detailed below) and look for connections.

Some things you should listen for/ask about:

- a. When students sketch the next two figures, do their figures follow all of the patterns identified and shared in step 4?
- b. How do students start their sketch of the next two figures? Some might draw three squares across and then draw the “legs” coming down. Some might draw one square in the middle and then draw the legs coming down. Some might draw the first figure and then add some squares to the bottom of each “leg.” Try to take note of who is doing what.
- c. Instead of describing what the tenth figure will look like, some groups might write, “The 10th figure has 23 squares in it.” If you come across this, ask them to read the question again.

7a

When beginning to work with visual patterns, there are often 1-2 students who struggle with drawing the next two figures. It depends on which observation(s) they are using. Say for example they are only focusing on the number of blocks. There are 11 squares in the 4th figure. Eleven squares can be arranged in a lot of different ways. You can help these students by referring them to all of the patterns identified in steps 3 and 4. It not only has to have 11 squares, but it has to have a height of 5, etc.

7b

The first two ways are common and almost always both come up. The third way is less common, and needn’t be forced, but is a special treat when a student see the figures in that way.

Ask them, *“What will those 23 squares look like? How will they be arranged?”*

- d. Some students might assume that if the 5th figure has 13 squares, the 10th figure will have double that amount, or 26 squares. If that happens, you might ask if there are any patterns they notice in the table. They probably already noticed that the number of squares goes up by 2. Ask them to continue the table and see if they get the same answer. Then walk around some more—give the group a chance to discuss on its own which answer they think is correct—the 23 or the 26. Check back in a few minutes and see where their conversation is. If it has stalled and there is no consensus, you can tell them if the 4th figure has twice as many squares as the 2nd figure, but it is much better if they can get there on their own. If they do, make sure to ask how they decided.
 - e. Which group has a clear set of steps for figuring out how many squares are in the 99th figure? Ask them to talk you through their steps. Look for one or two that are clear and ask the group if they would be willing to share their method during the debrief. Ask them to spend a few minutes talking about how they will demonstrate their method so it is clear to the other folks in the class.
- 8** Once the groups are mostly done with the first 5 questions (don't worry if no one has gotten to the bonus question), bring the class back together for a whole-class discussion.

Guide for Facilitating the Whole Class Debrief and Discussion

The goal in this scaffolded approach to visual patterns is to start concrete and get more and more abstract. If available, give students the option to use square-inch tiles to lay out the next two figures.

“Sketch the next two figures.”

When going over this question, I tell students, *You are the brain and I am the hand*. From their desks I have them give me explicit instructions for how they want me to draw the 4th figure. There are a few different ways they might be looking at the figures and you want to draw out as many different ways of seeing the pattern as possible. What is important here is to get them to be clear about how they want you to start.

The first student might have you start by drawing the three squares across. Draw it the way they describe, next to the first three figures you have on the board. Color in the top three squares and then describe their way of seeing it—*So Roberta had me draw three across the top and then draw the legs underneath. Did anyone see it a different way?*

Try to find a student who drew the legs first and then added the square in the center of the top row (or, put another way, a student who drew the square in the center of the top row and then drew the legs coming down). Draw it and then color in the center square. Then ask if anyone saw it in a different way. If they did, you can have them describe how to draw the 6th figure.

When you are done, you'll have something like this (see image at right):

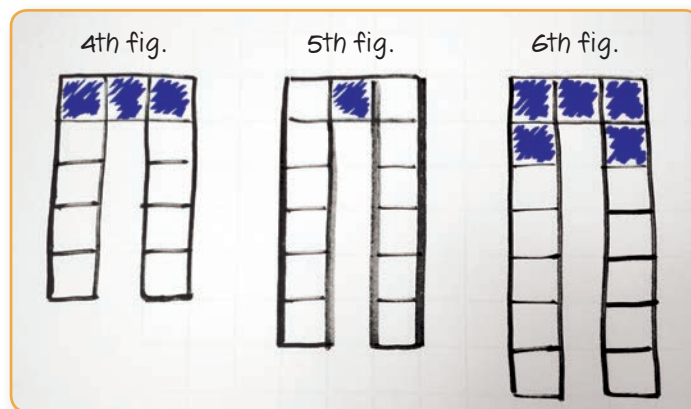

“Complete the table.”

Draw the table on the board and make sure you leave space below so you can continue the chart later in the debrief. Students will likely mention that they see a pattern in the number of squares: they go up by 2. If they don't bring it up, ask if anyone sees any patterns. Either way, write it on your table.

Ask the class how the table was helpful to their work. If it doesn't come up, mention that the table can help us organize the information without having to draw out all the figures. It also helps us identify more patterns.

“In a few sentences, describe what the tenth figure would look like.”

Remember, you want a written description for this one. By all means, talk about the different ways students came up with 23 (and discuss any disagreement about that answer). But then get some descriptions on the board. Try to write down exactly what the student says. Then, draw a picture based on the description only—if you can playfully “misinterpret” any details and come up with a different figure, please do. Give students the opportunity to revise their description until your figure matches the picture they had in mind.

You should end up with descriptions similar to these:

“Draw three squares across. Then draw ten more squares down under the left square and another ten squares down from the right square.”

“Draw a column of 11 squares. Draw another square to the right of the top of the column. Draw another column of 11 squares down on the other side of the center square.”

You want at least one picture of the 10th figure on the board.

This “going up by two (+2)” is the iterative (or recursive) rule. The iterative rule is a rule that you can use to find the value of a term (number of squares in this case) by using the value of the previous term. For example, if the 10th figure has 23 squares, I know the 11th figure has 2 more, or 25 squares.

It's ok for the words to feel awkward. The eventual takeaway is that algebraic notation has a purpose. It is a tool that allows us to express our way of thinking clearly and concisely. Of course, you should not mention this yet.

“Explain how you would figure out the number of squares in the 99th figure.”

TEACHER NOTE: Students can certainly use the iterative/recursive rule to answer this question and there is usually someone who continues the chart all the way to the 99th figure. Which is great. But this question also encourages students to look for an explicit rule. When we put students in a situation where they are telling themselves, “there has to be another way”, they will often start looking for patterns. We should make this explicit whenever it happens.

For this question, ask one of the groups that you identified during the group work problem-solving to come up and share their approach. After the group presentation(s), if it hasn’t come up, ask the class how the 201 squares in the 99th figure would be arranged.

There are a few ways they might answer this one. They might recognize that if you draw three across the top, the number of squares down each column is equal to the figure number. They might also say, “We have 201 squares total. If we put three across the top, that leaves us with 198. Since both columns are equal, if we divide up the 198, we get 99 in each column.”

For the other way of seeing the figure, they might recognize that after you put the one square in the center, the number of squares in each column is one more than the figure number. They may also use the 201 and say, “Well, after we put the 1 in the middle, we are left with 200 squares, so that is 100 on each side.”

If they are not sure, you can refer to the two (or three) different ways of drawing the 10th figure and give them a few minutes to think about your question.

Teacher: How would (*student’s name*) start drawing the 99th figure?

Student: She would draw three across the top.

Teacher: How many squares would there be in each column going down?

Student: 99.

Teacher: What about (*student’s name*). How would she start drawing the 99th figure?

Student: She would draw the center square. She would then draw 100 squares down each side.

By the end, you want to create a visual sketch model that students can use as a shorthand.

An **explicit rule** is a rule that allows you to find the value of any term in the pattern without needing to know the value of the term before it. If you look at visual patterns in the context of functions, the explicit rule is the function rule. (And the iterative/recursive rule is the rate of change).

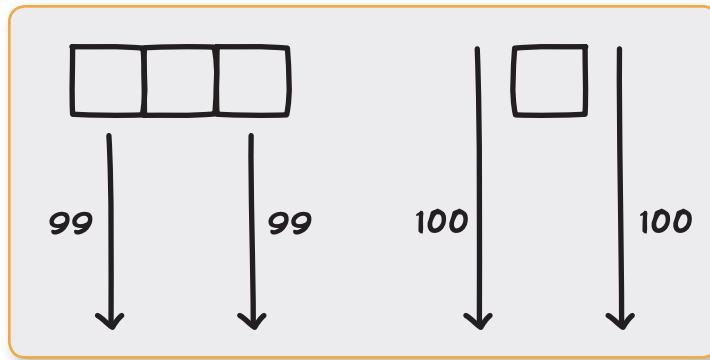

“In a few sentences, describe how you would determine how many squares there are in any figure in the pattern.”

Give the groups five minutes to work on the bonus question. Some of them who either didn’t have time or were too intimidated to answer it before will have a little more confidence. If any groups finished it during the group problem-solving, ask them to try to use the debriefing notes from the board to try and find a second way.

After five minutes, bring the class back together. Remind them that when we look at information, make observations and find patterns, those patterns allow us make predictions.

The bonus question is asking us to predict how many squares there would be in any figure number, so let’s look at how many squares there are in the figure numbers we already know.

Point to the visual sketch model you drew for the 99th figure. Ask how many squares are in the 99th figure. They’ll either say “ $99 + 99 + 3$ ” or “ $2 \times 99 + 3$ ”. Whichever form they use, record it on the board and use the same form for the rest.

Ask, *How did we arrange the 10th figure?*

And record their answer— either “ $10 + 10 + 3$ ” or “ $2(10) + 3$ ”

Continue all the way to the 1st figure.

Then, ask students how they could figure out the number of squares in the 47th figure, and record their answer: “ $47 + 47 + 3$ ” or “ $2(47) + 3$.” Do it a few more times if it feels necessary.

Then ask your class: *What is changing? What is staying the same?*

Teacher: What is changing?

Students: The figure number.

Teacher: What is staying the same?

Students: We are always doubling the figure number and we are always adding three.

You want to start with the view of the figure that starts with the three squares across the top. When we get to generalizing the rule in a few steps, it is easier to work with the rule that has the simplest form of figure number in it. I recommend the first one, but the others can certainly be used as extensions for faster students. The first can be written as $99 + 99 + 3$ and generalized as $2n + 3$. The other one is $(99 + 1) + (99 + 1) + 1$ and generalized as $2(n + 1) + 1$. The rule that involves the 1st figure can be written as $(99 - 1) + (99 - 1) + 5$ and generalized as $2(n - 1) + 5$.

This is an opportunity to introduce students to writing $2 \times 99 + 3$ as $2(99) + 3$.

If you prefer them to use the $2n + 3$ format, encourage them to do so by asking for another way to write adding a number to itself.

The first time you do visual patterns, focus on building only one of the ways of seeing the figure into an algebraic generalization. For future visual patterns, looking at more than one can be a great leaping off point for talking about equivalent equations.

Ask everyone to write in their notes, the steps they would take to find the number of squares in any figure number. Walk around and see what folks are writing and decide a few to share. Take a volunteer and record their steps on the board. Ask if their steps would always work. Have the class test it with the figure numbers we've already worked with, until everyone agrees it would work. Then ask if anyone has a different way.

Once you have at least one clear set of steps on the board that works, under the $47 + 47 + 3$ or the $2(47) + 3$, write an n . Say, *I don't know what figure number this is, but whatever figure number it is, what will I do to figure out the number of squares in it?*

Record their response—either " $n + n + 3$ " or $2(n)+3$.

At the end, this piece of the board should look something like the image on the right:

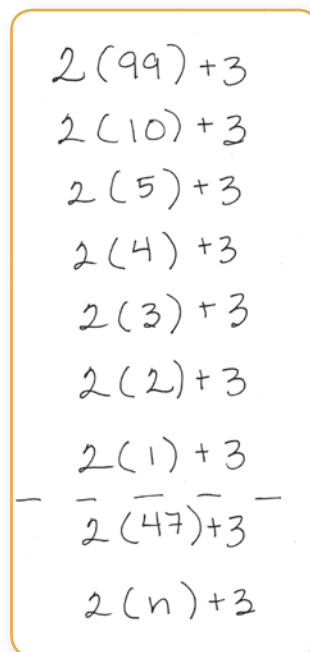

9

Using a variable to stand for the independent change in a function—as we are using it here—is only one way to use a variable.

If you want to go a little deeper into this use of a variable, you might ask some follow-up questions: What does n represent? How many different numbers can n be?

9 Ask if anyone knows the word for when we use letters like “ n ” to represent numbers. Chances are, someone will throw out the word “variable.” Ask them what it means when something varies and remind them of your question about what was changing and what was staying the same. It is the element that was changing—in this case, the figure number—that we represent with a variable. Have students add the following definition of a variable to their notes: “When working with visual patterns, the variable is the part of an explicit rule that changes for each figure.”

10 Give out THE ARCH PROBLEM, PART 3. It could be either the final problem-solving activity of class or it could be given as a homework assignment.

NOTE TO TEACHER: It’s too much to get into this the first time you look at a visual pattern, but this question, “Which figure will have ___ squares?” can be used to build towards solving one-variable equations—i.e. solving for “ n ” in the equation $2n + 3 = 175$. But hold off on making that explicit until after they’ve come up with their own methods and shared them. Give students a chance to work on it as it is written and it can become the foundation of students solving for a specific unknown, except instead of us having to tell students how to do it, they can tell us.

Debriefing this question is a good moment to compare an equation using a variable that has one specific value to a function, which is about the functional relationship, where the variable can be any number. Ask how this use of the variable is different from the way we used it when we came up with the rule, $2n + 3$.

■ **“Which figure will have 175 squares in it?”**

There are a few strategies you should look for to have students share.

Some students might use guess and check. You should go over this method first.

They already know the 99th figure has 201 squares, so they know it is smaller than the 99th figure. Say, they start with the 80th figure. They will test each guess by using the rule—doubling the figure number and adding three—until they get to the 86th figure and realize the $2(86) + 3 = 175$.

Some might refer to the visual sketch of the figure and say something like, “Imagine you have 175 squares. You put three across the top, leaving you with 172 squares. You divide the 172 squares by 2 and divide them evenly to each side of the figure. That would give us a figure with three squares across and 86 squares down each side. So it is the 86th figure.”

■ **“Which figure will have 44 squares in it?”**

This is a bonus question because it is a trick question. There is no figure in this visual pattern that will have 44 squares in it. Many students will come to that conclusion, but the goal is for them to be able to explain why and how they know that is the case.

You need to be able to subtract 3 from the number and end up with an even number. Put another way, if you put the three squares across the top, you need an even number of squares to distribute between the two columns. 44 minus 3 is 41, which cannot be divided evenly into two columns.

- 11** Re-write “Algebra is the generalization of arithmetic” on the board. Ask students to do a pair share and discuss how the sentences connects to the work they’ve been doing on the arch problem.

This math log was adapted from *A Collection of Math Lessons: From Grades 6 through 8* by Marilyn Burns and Cathy Humphreys



Check-Out/Exit Ticket

- Give students a minute or two to look over the whole board. Tell them you are going to give them some time to reflect on what they learned in class.
- On a separate piece of paper—you'll be collecting it—have students take notes on the following items:
 - The date of the lesson.
 - What do you think would be a good title for today's class?
 - What happened in class today?
 - What did you learn about today?
 - What do patterns have to do with algebra?

Introduction to Visual Patterns

Examine the following pattern:

1, 2, 3, 4, 1, 2, 3, 4, 1, 2...

- 1 What will the 19th number in the sequence be?
- 2 What will the 41st number in the sequence be?
- 3 What will the 91st number in the sequence be?

Adapted from *Math Matters* by Suzanne H. Chapin and Art Johnson

Introduction to Visual Patterns

“1, 2, 3, 4 Pattern—The First 30 Numbers”

What patterns do you notice?

Number in Sequence	Number
1st	1
2nd	2
3rd	3
4th	4
5th	1
6th	2
7th	3
8th	4
9th	1
10th	2
11th	3
12th	4
13th	1
14th	2
15th	3

Number in Sequence	Number
16th	4
17th	1
18th	2
19th	3
20th	4
21st	1
22nd	2
23rd	3
24th	4
25th	1
26th	2
27th	3
28th	4
29th	1
30th	2

The Arch Problem, part 1

Look at the figures below. What do you notice?

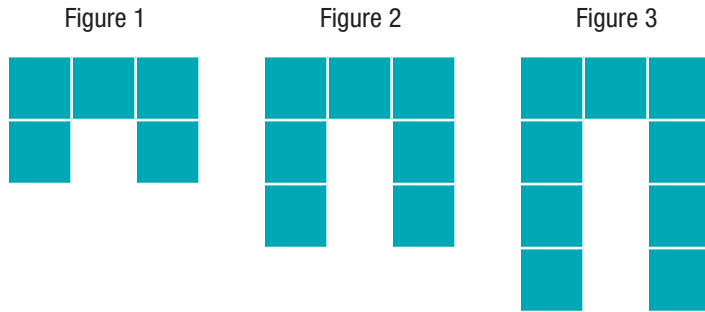

Complete the following sentence:

As the figure number changes, _____
 also changes.

The Arch Problem, part 2

1 Sketch the next two figures.

Figure 1



Figure 2



Figure 3



Figure 4:

Figure 5:

- 2 Complete the table to the right.
- 3 In a few sentences, describe what the tenth figure would look like.

Figure Number	Number of Squares
1	
2	
3	
4	
5	

- 4 Explain how you would figure out the number of squares in the 99th figure.

- 5 BONUS QUESTION: In a few sentences, describe how you would determine how many squares there are in any figure in the pattern.

The Arch Problem, part 3

Which figure will have 175 squares in it?

BONUS QUESTION:

Which figure will have 44 squares in it?

Lesson Plan II: An Open Approach to Visual Patterns

In the scaffolded approach to visual patterns, the teacher identifies the change that students should observe. In many visual patterns, this change will be in the number of squares that make up the figure in each stage of the sequence.

In the pattern below, for example, you could count the number of squares in each figure, create a table to collect the data and eventually come up with a rule for finding the number of squares in any figure.

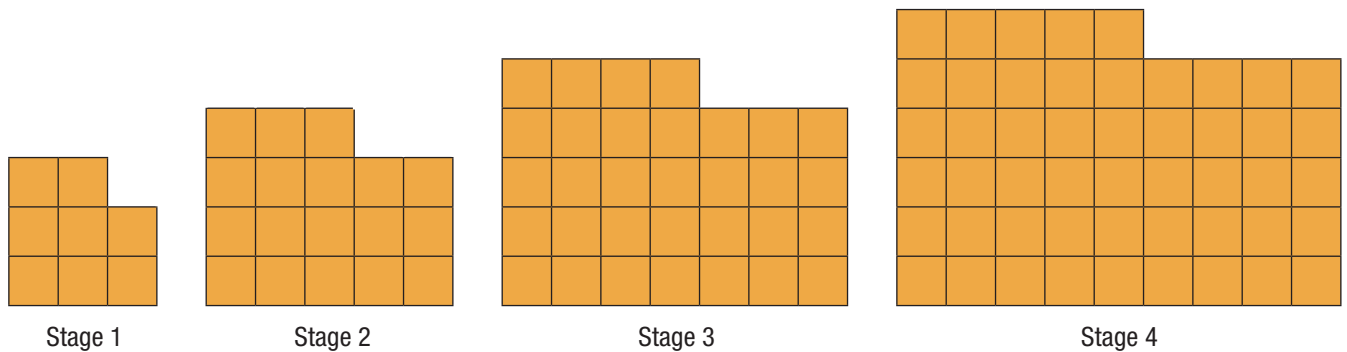

This is just one way to look at change in a visual pattern. You could also ask students to find height of the 10th figure or the width of the 20th figure. How many vertical lines would it take to draw the 15th figure? If you built one of these figures out of toothpicks, how many would you need? What is the perimeter of the 30th figure? When we look at visual patterns with new eyes, we see that there are many different kinds of change that can eventually be represented algebraically.

In this lesson plan, we use an open, less scaffolded approach to encourage students to find different kinds of change in visual pattern sequences and then investigate that change. The goal is to generate interest, creativity, and flexibility in student thinking.

We want to balance scaffolding and openness. As students become comfortable working with visual patterns in a scaffolded approach, we can begin to remove the scaffolding and release responsibility to students to make decisions about what they want to investigate and how they will organize their work.

The main activity here—looking at a visual pattern and writing questions—can also be used as warm-up activity before using a more scaffolded approach similar to what is described in the first visual pattern lesson above. This can be useful to generate different ways of seeing a visual pattern before settling in to understand one kind of change together as a class.

OBJECTIVES

COMMON CORE STANDARDS OF MATHEMATICAL PRACTICE

MP1; MP2; MP3; MP4;
MP5; MP6; MP7; MP8

- ✓ Students will reflect on their own persistence and practice self-awareness while doing math.
- ✓ Students will write their own questions in response to a visual pattern.
- ✓ Students will consider audience when writing questions and have an opportunity to revise their questions based on peer feedback.
- ✓ Students will annotate posters of each other's work.

ACTIVITY 1 Launch: Persistence Spectrum

MATERIALS:

- A spectrum drawn on newsprint or the board • stickies

STEPS:

- 1 Before class, draw a large horizontal double-headed arrow as a scale (spectrum) on newsprint or the board. Above the arrow (leave enough room for students to place stickies with their name), write the following statement: "When something is hard, it makes me want to work on it more." Underneath the arrow, write **Strongly Agree** and **Strongly Disagree**, as shown below:

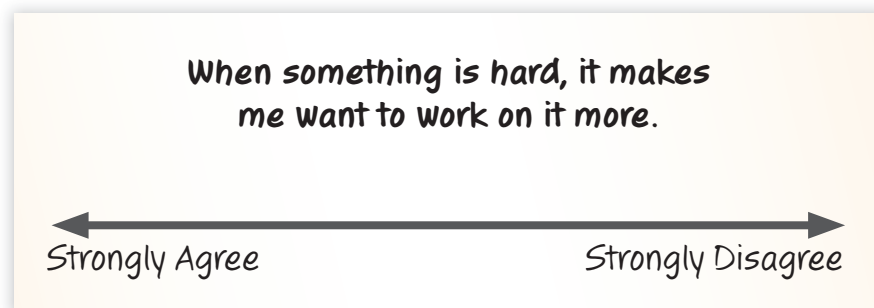

- 2 When students come into the room, ask them to write their name on a stickie big enough for everyone to see and then place their name along the scale. Encourage students to choose a spot along the scale that accurately indicates their feelings about the statement. They don't have to choose strongly agree or strongly disagree. They can place their name anywhere along the spectrum. As a model, place your name along the scale as well. When I did this lesson, I put my name on the left, but not all the way over. I explained that it depended on the situation. I enjoy challenges sometimes, but only if I feel that I have a fighting chance. I sometimes get discouraged and want to give up. This is a nice opportunity to have individual conversations with students how they think about this statement.

- 7 You might say at this point that you have a challenge for them today that you think will be interesting and you hope that by the end of class, some students will move their names towards the left on the spectrum. We don't expect huge changes in one day. We're looking for slow and steady improvements.

ACTIVITY 2

Writing and Sharing Questions About Visual Pattern #141

VOCABULARY

pattern
figure
stage
series

MATERIALS:

- Newsprint with drawings of the four stages of visual pattern #141 large enough for the class to see from their seats (easel paper with a grid is helpful)
- Handout: Visual Pattern #141
- large strips of paper (newsprint cut horizontally into 4" wide strips)
- tape
- markers

TEACHER NOTE: This is one of the more challenging puzzles from visualpatterns.org because the number of squares in each stage grows quadratically. We recommend trying a few linear growth sequences with your class before this one. You can, however, use most elements of this lesson plan with any of the visual patterns collected below.

STEPS:

1

We want to pair students so that they can support each other, but we also need to make sure both students have the opportunity/time/space to grapple with the problem in their own way.

An open approach to looking at visual patterns can allow advanced students to tackle more difficult problems, while other students work on more accessible questions. If the groups are more homogenous, students can choose questions that seem doable to them.

- 1 Before starting this activity, break your class into small groups of 2-3 students. Depending on the culture of your class, you can let your students choose groups or you can decide on the groups yourself. Either way, we recommend sharing advice like this before you begin:

You'll be working in small groups for a lot of the class today. I know for myself that it doesn't feel great when I'm doing math with someone and they race ahead of me. If you're working with someone who takes their time, try to be patient and work together with them, without rushing ahead.

It's important that we all are able to have time to think and come up with ideas without being rushed. Try not to just give each other answers. If you are a team, work together and make sure that everyone understands before you move forward.

- 2 Post easel paper with visual pattern #141 up on the wall. You might hang it before class and fold it up with tape in order to keep the

activity a surprise. Ask students to look at the pattern and think about what is happening with these figures. There isn't anything in particular for students to notice at this point in the lesson, but they may come up with some ideas that help other students get started with the worksheet that follows. This also might be a good time to define vocabulary they will be using in the rest of the lesson: *pattern, figure, stage, series*.

This line of questioning can be helpful to introduce students to the new visual pattern before working independently:

- *What do you notice?*
- *What patterns do you see?*
- *What could you say about the figures as they grow?*
- *How would you describe the series to someone who couldn't see what you're looking at (over the telephone, for example)?*

- 3** Give out the VISUAL PATTERN #141 handout. Ask students to work individually. They should start by describing patterns that they see: *Do you see a pattern? Describe in words what you see.* Encourage students to write sentences, or at least notes, with details about the figures. Some preliminary examples might include:

- *The drawing is getting bigger in every stage.*
- *There are more squares in each figure.*
- *There are more missing squares each time.*

Encourage students to include details: *In what way is it growing bigger? How many more squares do you see? Which squares are missing? Can you show me how the figure is growing? How can you include these details in your written description?* More precise, rewritten sentences might include:

- *Each drawing is one row taller than the last one.*
- *Stage 2 has 10 more squares than Stage 1. Stage 3 has 14 more squares than Stage 2.*
- *There is one more missing square each time. For example, Stage 1 has one missing square and Stage 2 has two missing squares.*

- 4** After most students have written some descriptions, encourage them to start on the second prompt: Think of some questions you could ask about this series of figures. Write 2-3 questions below.
- 5** After students have had a few minutes to write questions, ask them to get into their small groups. Say, *Share some of your questions with a partner and then write more questions.* The goal is to come up with as many questions as possible.

2

Remind students that we will be spending time in group discussion today and should remember to be respectful. Ask student to try these sentence starters:

"I agree with ____ because..."
or "I respectfully disagree with ____ because..."

After a few more minutes of walking around, and listening to students' conversations, offer a few questions that occurred to you, such as, *What would Stage 5 look like?* and *Would Stage 10 have an even number or odd number of squares?*

If this is the first time your students have approached a problem like this in an open way, they will most likely need some guidance in forming questions, but let them struggle for a bit before you help them.

- a. If students have trouble coming up with questions, you might write the following phrase under the visual pattern on newsprint:

In the figures below, as the stage changes, _____ also changes.*

5b

We want students to struggle, but we don't want students to shut down with the openness of this task. If the struggle becomes unproductive, we should talk to students individually and explain, "Here's what I mean..." and offer some model questions.

What would the next figure look like if I drew it?

How high would the next figure be?

How many squares would there be in the 8th figure?

What questions can you think of?

5d

There are different ways to structure a class around student questions. You might ask the group to work on one particular question first, and, if there is time or for homework, students can move on to other questions that were generated. Most importantly, students have more ownership on the work they do on the problem. Asking questions about patterns and working to answer these questions is way for students to act as mathematicians.

Ask students to fill in the blank with as many different words as they can. Possibilities include:

- the number of squares
- the number of columns
- the number of rows
- the width
- the height
- the perimeter
- the area
- the number of line segments
- the number of intersections

- b. Now, ask students to use these observations in order to form questions about the figures. For example, they might ask: "How many columns will the Stage 10 figure have?" Give students a few more minutes to brainstorm questions in their groups.
- c. When each group has at least a few sentences completed, say, *Together with your group, decide which questions you'd like to share with the class and write them on these large strips of paper.* Hand out a couple strips of paper and a marker to each group.
- d. Collect the strips as they are written and tape them up on the wall near the newsprint with the visual pattern. You might tape them in rows at the front of the room so that everyone can see them. You can hang the questions as they come in, or you can try to group them in categories. Make sure that each group has contributed at least one question.

*FOOTNOTE: Thank you to Blake Peterson (Brigham Young University) for suggesting this prompt and brainstorming activity in his workshop at the National Council of Teachers of Mathematics Conference, 2015. You can see the presentation for his workshop, "Intellectually Engaging Problems: The Heart of a Good Lesson," at <http://nctm.confex.com/nctm/2015AM/webprogram/Session31618.html>.

There are many possible questions that students could ask. Here are is a list of questions brainstormed by teachers in a professional development workshop:

What would the 5th stage look like?

What will the 50th stage look like?

How many squares would there be in stage 5?

How many squares are there at stage 10?

How many squares do you have to add to get the next figure each time?

Will the 10th stage have an odd or even number of squares?

Will the bottom row always increase by 2?

How many columns will stage 25 have?

Will it always get one taller each time?

How many rows will stage 25 have?

If these were tiles on a kitchen floor, how many tiles would you need for kitchen 5?

What is the area and perimeter at each stage?

If you had to find out the area of the floor after taking out a piece, what would the area be?

How much does the perimeter increase at each stage?

How can we predict the area at stage 10?

Imagine that these figures were made out of toothpicks. How can you find the number of toothpicks in stage 5?

Is this a linear, exponential or quadratic relationship? Or all of the above?

What would stage 0 look like?

- 6** When all the groups have contributed questions for the wall, read the questions aloud to the group one by one. If students can't see the questions from their seats, you might ask them to come up to the board to look at all the questions while you read them aloud. Say, *As I read the questions, look at the figures on the board and see if you understand the question.* Read questions aloud one at a time. After reading all the questions, engage students in the following line of questioning:

6

One goal of this discussion is to help students think about audience while writing. In hearing other students express their understanding of a question, the writer will learn whether they have communicated clearly enough to be understood. After this discussion, students should be given an opportunity to rewrite their questions if they need to clarify their intention. This section of reading and rewriting questions is not essential to the larger activity, and can be skipped if time is a constraint.

- a. **To the class:** *We're going to spend some time looking at a couple of the questions you wrote. We won't have time to look at all of them in detail, but I want us to practice writing with precision so that others can understand our thinking. When we write something, we know what we mean, but do others have the same idea? This is an important skill for the HSE exam, in which you will have to write short explanations on all subjects of the test, including math.*

We can help each other improve our abilities to communicate our ideas clearly. We want to be understood when we talk about our mathematical ideas. Other people can help us do that by sharing what ideas they have after reading what we write, and giving us a chance to change our words to get our ideas across even more clearly. So, this is an opportunity for us to practice writing as a way to communicate mathematically. Which of these questions are interesting to you? Are there any questions here that you are not sure what they mean? Give an example of a question you like that isn't your own.

- b. **To a volunteer:** *Could you read the question aloud to the group?*
- c. **To the same student:** *Looking at the visual pattern (the large drawing on newsprint), please explain your understanding of the question.* (Teacher note: Ask the writer of the question to listen carefully.)

Let's say, for example, that the question chosen was: Will the bottom row always increase by 2? We would expect the volunteer who read this question to be able to show the class how the number of squares across the bottom is 2 more in each stage. Another way to say this is that there are 2 more columns in each stage of the figure. Ask the student to show their understanding of what the question is asking by demonstrating visually with the figures on newsprint.

- d. **To the class:** *Before we ask the writer to respond, does anyone have thoughts about this question? Does anyone have a different idea about what this question is asking? What gave you that idea? If you could ask the writer one question, what would it be? What would you like to be explained?*
- e. **To the writer/s:** *Is this what you meant by your question? Is there anything that you want to explain about the change you see in the figures? Would you change anything about how you wrote the question?*
- f. **To the class:** *What's another question someone finds interesting? What's another question that you're not sure what it means?*

ACTIVITY 3 Work on Visual Pattern #141

- 1 Individual Work:** Students should now start to work on one of the questions. The groups should each choose questions that are interesting to them and they feel like they might be able to answer. Each group should choose a question to work on, but to start, each student should work on the question independently. Make it clear to students that they should work alone at first, without help or conversation with each other. Say, *Choose a problem / pick a question, with your partner, and then work on the question alone.*
- 2 Pair Work:** Give the groups time to talk about what individual students each did. While students are sharing with their partners, visit each group to get a sense of the work each person had done and the conversation of the pair. This will allow you to guide the whole-class discussion that follows.
- 3 Whole Class Discussion:** One way to organize the whole group activity is through student posters. Having posters can help other students focus on other students' thinking and allow them to ask targeted questions. Here is a great way to organize a gallery walk of student work:
 - a. Groups create posters on newsprint or a section of the whiteboard.
 - b. One partner stands by the poster and fields questions while the other walks around to look at the other posters, then students switch.
 - c. Students annotate each others' posters with questions and comments on stickies.

You can also ask each group to report out and give a general sense of what they discussed. Since students will have worked on different questions, it is important that other students be given time to understand their questions, the patterns they saw and the conclusions they came to.

1

This set of instructions gives problem-solvers time to try some things on their own, but with the expectation that they are going to have to explain their ideas and talk about what they did with a partner. Individual students should come up with some of their own ideas first before talking with a partner. We want to insure different student voices are heard. Students need to be in a place where they are ready to contribute ideas and hear the ideas of a partner.

ACTIVITY 4 Extension Questions

MATERIALS:

- Brainstormed questions about Visual Pattern #141
- graph paper
- scaffolded worksheet on Visual Pattern #141

STEPS:

- 1 Some groups will finish answering their questions sooner than others. One of the nice things about this approach to using visual patterns is that you should now have a long list of questions that can be used as extensions. You can simply ask the group to choose another question from the wall to work on.
- 2 Another way to think about extensions is to ask groups to represent their work in different ways and generalize the answers they have discovered. You might give them newsprint to present their work, and respond to some of the following extensions.
 - a. If the group has worked on the question, “How many columns will stage 25 have?”, you might ask them to organize their results so that someone else can see the pattern they see. How many columns are there at each stage? This might lead to a table or a chart, but we recommend letting students decide how to present the pattern.
 - b. If a group has a chart or table: Figure out a way to determine the number of columns in any stage. What would a rule in words be for this pattern? The answer for this question might be, *multiply the stage number by two and add one*.
 - c. If the group has a rule in words: Find an algebraic equation that works for the n th stage. The answer in this case might be, $2n + 1$.
 - d. If the group has an equation:
 - Graph the pattern you are investigating on graph paper.
 - Find the slope (or rate of change) of the column growth. Two, in this case.
 - Find the y -intercept (or starting amount) of the column growth. One, in this case.

2

One challenge to using an open approach to visual patterns can be that it is difficult to predict the questions that students will choose and have the answers prepared. We recommend spending some time working on the visual pattern before class, ideally with other teachers, so that multiple ways of seeing patterns and related algebra are revealed. It is certainly possible to do this work on your own as well. Put yourself in the position of a student, write a few questions about the visual pattern, then work to answer them. In the process of looking at patterns, asking questions and finding rules, you will discover connections that your students will make as well.

- 3** Finally, you might prepare a scaffolded worksheet with a set of questions related to a particular kind of change in the visual pattern. For example, you could create a worksheet related to the number of squares in each figure or, for more of a challenge, the number of toothpicks necessary to build each figure. Whatever kind of change you identify, you can ask the following questions in a worksheet:
- Draw the next two figures.*
 - What patterns do you see?*
 - Create a chart with the data you have gathered. (Insert a blank table with headers of Stage # and Squares (or toothpicks, columns, or other change.)*
 - In a few sentences, describe what the 10th figure would look like.*
 - Explain how you would figure out the number of _____ in the 25th figure.*
 - In a few sentences, describe how you would figure out how many _____ there would be in any figure in this pattern.*
 - Which figure will have (some number) _____?*



Check-Out/Exit Ticket

This is a process that can be used at the end of class to get quick feedback from students and encourage discussion about ways of learning.

- *Think about today's class. In your head, think of a number 1–10 that represents how you feel that class went and what you learned. Are you ready? Don't say it yet. One, two, three. Say the number. (Listen to see if you can hear more than one number at once.)*
- *I didn't quite hear everyone. Can we try again? One, two, three. Everyone at the same time. Say the number.*

Ask a couple volunteers to explain their number. You might start with a couple lower numbers, like a 5, to hear from someone who wasn't so positive, then hear from a couple people who had higher numbers. This should be a short discussion, though, and just enough so students feel comfortable giving feedback. End session.

Visual Pattern #141

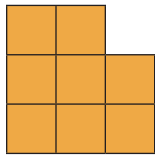

Figure 1

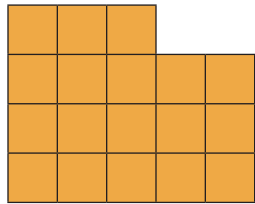

Figure 2

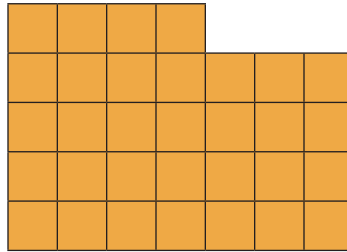

Figure 3

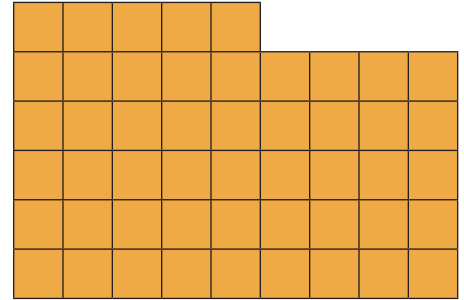

Figure 4

1 Do you see a pattern? Describe in words what you see.

2 Think of some questions you could ask about this series of figures. Write 2-3 questions below.

A Sample Progression of Visual Patterns

Visual Pattern 1: The Upside Down T Problem

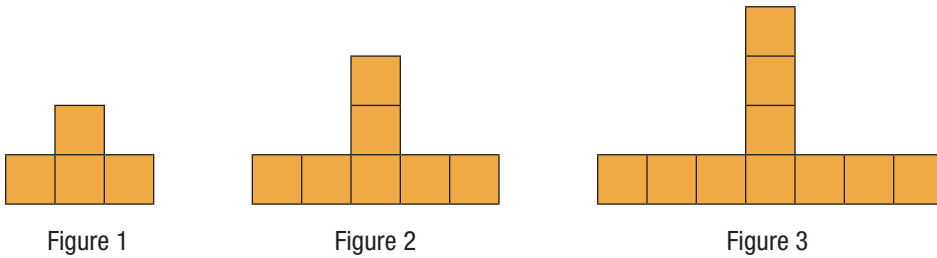

Visual Pattern 2: The Cross Problem

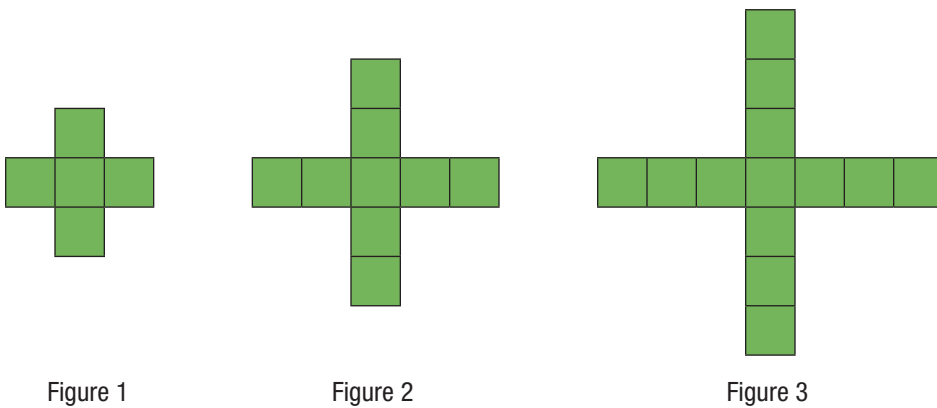

Visual Pattern 3: The Factory Problem

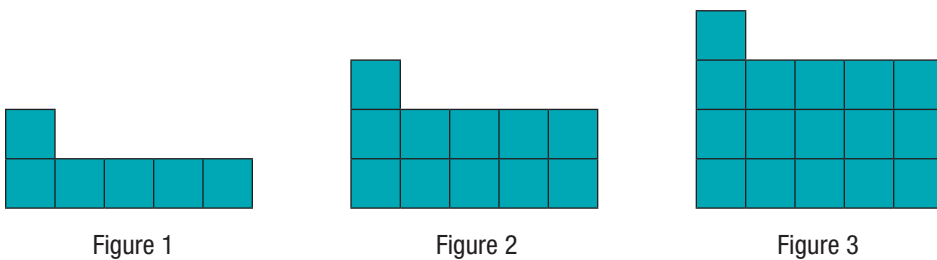

Visual Pattern 4: The Zig Zag Problem

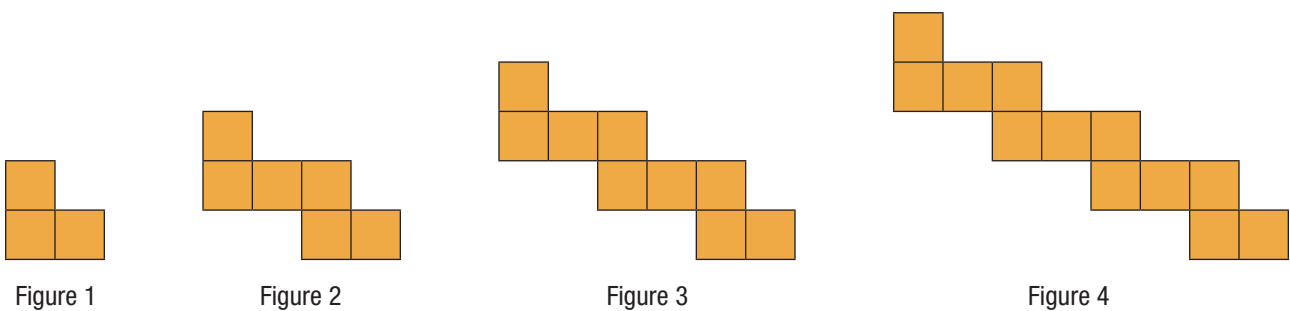

Visual Pattern 5: The I Problem

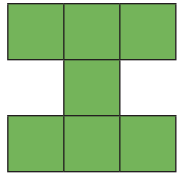

Figure 1

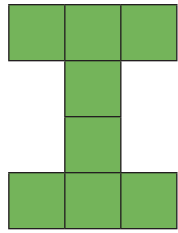

Figure 2

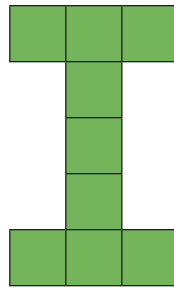

Figure 3

Visual Pattern 6: The Columns Problem

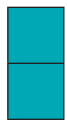

Figure 1

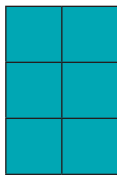

Figure 2

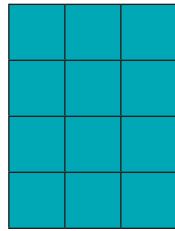

Figure 3

Visual Pattern 7: The Steps Problem



Figure 1

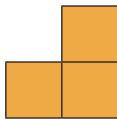

Figure 2

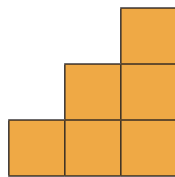

Figure 3

Visual Pattern 8: The Pool Problem

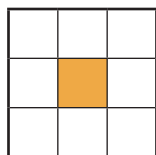

Figure 1

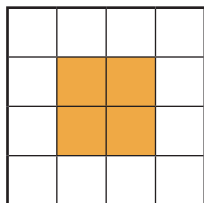

Figure 2

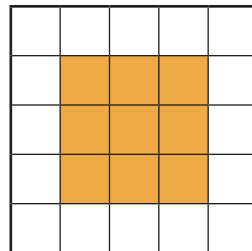
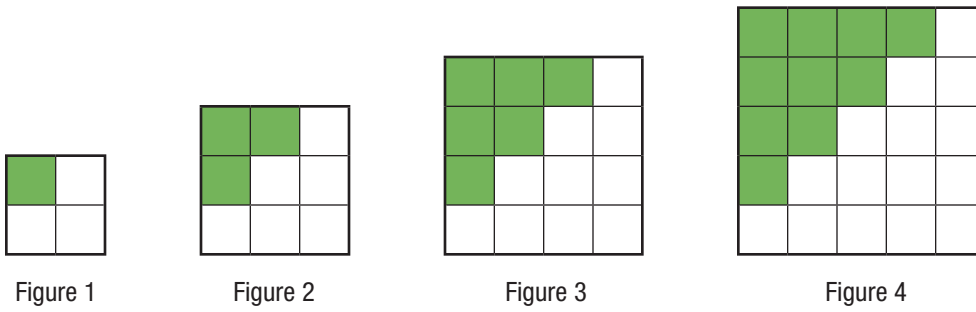
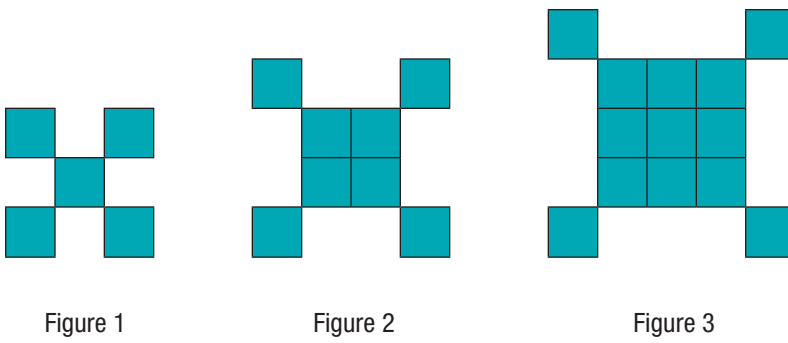

Figure 3

Visual Pattern 9: Square and Triangular Numbers



Visual Pattern 10: The Lunar Lander Problem



Visual Pattern 11: The Lobster Claw Problem

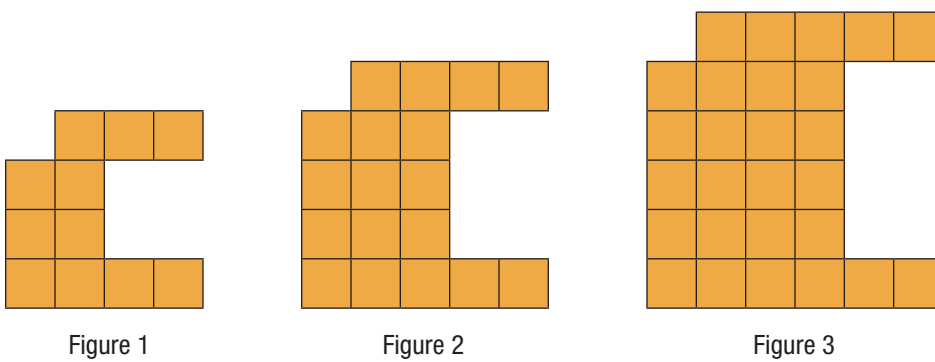

Visual Pattern 12: The Super Columns Problem

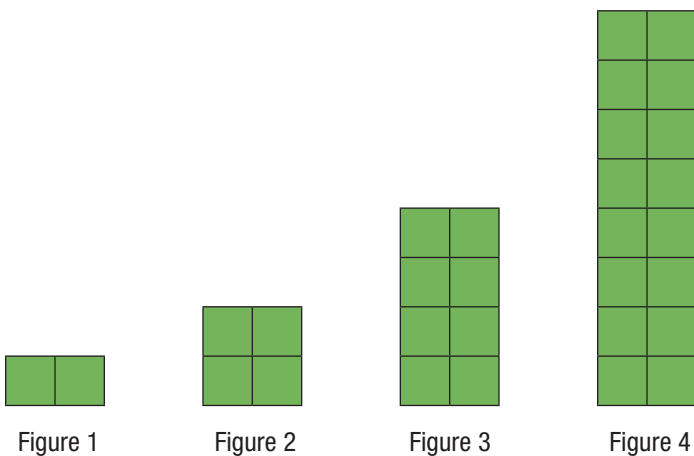

Additional Recommended Resources for Visual Patterns

Visualpatterns.org

This is a great resource for exploring visual patterns with your students. It is a very simple and wonderful website, created by Fawn Nguyen, a public middle school teacher in Southern California. The site is a collection of 180 different visual patterns (with new ones posted all the time). For each pattern, you are given the first three figures/stages of the pattern. You are also told the number of squares in the 43rd figure in the pattern (as a way to check whether you have the correct equation). You can email Fawn and she will send you the “answers”—the function equations that go with each visual pattern. This includes many of the patterns in the suggested progression, many of which were taken or adapted from this website.

Grade 6 Rocks Visual Patterns

<http://fawnnguyen.com/grade-6-rocks-visual-patterns/>

Fawn Nguyen (creator of visualpatterns.org) also has a great blog (<http://fawnnguyen.com/>) in which she tells stories about teaching and learning mathematics in the classroom. For more ideas about how to use visual patterns to develop your students' algebraic thinking and their understanding of functions, check out her post called “Grade 6 Rocks Visual Patterns.” The post has some great ideas from other teachers about how they have been using visualpatterns.org, as well as some examples from Fawn's own class.

Animating Patterns

<http://musingmathematically.blogspot.com/2013/08/animating-patterns.html>

This is a blog post by Nat Banting about using visual patterns with his students to support their work with linear functions. In the post, Banting reports on how he created vines (7-second looping videos) to bring visual patterns to life and help students see that visual patterns are about change.

The Border Problem

This problem is a classic and can be used in adult education classrooms at any level. Similar to the lesson on the Arch Problem, the border problem can be used in a variety of ways, including asking students to create their own equations and explore the equivalency of those equations. To learn more about the problem, check out these resources:

- **Youtube video of a teacher doing the border problem with students**
<https://www.youtube.com/watch?v=l6BJXKp2Sag>
- **Math Snacks—a brief video of two teachers talking about the problem**
https://www.youtube.com/watch?v=Tgaah_0Urvs

- **A brief blog post describing how a teacher used the problem in class**
<https://thematletes.wordpress.com/2013/10/07/the-border-problem/>
- **A Collection of Math Lessons, from Grades 6 through 8** by Marilyn Burns and Cathy Humphreys, Chapter 2: Introducing Algebra

You can also look at the border problem as a quadratic function, if you focus either on the total number of squares, or on the number of squares contained within the border.

“Developing Algebraic Thinking Through Pattern Exploration”

An article by Leslee Lee & Viktor Freiman, from *Mathematics Teaching in the Middle School*, This article models an exploration of a particular pattern and also describes different questions you could ask with a wide variety of visual patterns. It makes connections between the specific questions and the algebra content each develops.

Toothpicks by Dan Meyer—<http://threeacts.mrmeyer.com/toothpicks/>

This is a Three-Act Math Task by Dan Meyer that looks at toothpicks arranged in an interesting triangular pattern.

UNIT 9

Using Area Models to Understand Polynomials

Lesson Plan

This lesson plan explores a concrete way for students to conceptualize multiplication that ultimately leads to a deeper understanding of abstract algebraic topics, including multiplication and factorization of polynomials. We hope that this approach will allow both teachers and students to come away with a better sense of how multiplication of polynomials is connected to multiplication of integers. We should dispel the myth that math is a discrete set of topics. Ideally, we will see math more as “an interconnected body of ideas” (Swan, 2005).

In this lesson, we start with intuitive images of arrays, move to concrete representations of area with manipulatives and graph paper, and continue in scaffolded steps towards an abstraction of the area model of multiplication, which we will use to multiply polynomials.

This lesson is made up of the following sections, which should be followed in order:

- 1 Using Arrays to Explore Multiplication
- 2 A Measured Area Model
- 3 The Distributive Property
- 4 An Abstract Area Model
- 5 Applying an Area Model to the Multiplication of Polynomials

We recommend using these activities over a series of classes. In addition to developing fluency with multiplication of integers, fractions, percents, monomials, and binomials, the area model has the added usefulness of helping students understand area and perimeter. This model can create a shared visual language to refer back to when students struggle with multiplication in different contexts.

Check out Patricia Helmuth's CollectEdNY.org post on how she uses online area model manipulatives from the National Library of Virtual Manipulatives site to help students practice multiplication of whole numbers and fractions (<http://www.collectedny.org/2015/02/deepen-conceptual-understanding-in-math-with-virtual-manipulatives/>)

FOOTNOTE: We would like to thank the following educators for their inspiring workshops at the Commission on Adult Basic Education (COABE) 2015 conference: Amy Vickers, whose presentation on Rectangles as Problem Solving Tools greatly informed our understanding of the use of area models for teaching all forms of multiplication, including polynomials, as well as Lynda Ginsburg and Patricia Helmuth, whose workshop on quadratics and visual models demonstrated visual ways to contextualize factoring of quadratics. Amy's fantastic presentation, *Rectangles as Problem-Solving Tools: Use Area Models to Teach Math Concepts at All Levels*, can be found at <http://adulthoodresource.coabe.org>.

OBJECTIVES

Students will use area models to...

- ✓ Understand the connection between multiplication of integers and multiplication of polynomials.
- ✓ Understand multiplication as repeated addition.
- ✓ Develop a better sense of numbers, especially to compose, decompose and factor integers.
- ✓ Understand and use the commutative and distributive properties of multiplication.
- ✓ Calculate area and perimeter of rectangles.
- ✓ Multiply two-digit numbers.
- ✓ Multiply binomials and trinomials (polynomials).
- ✓ Understand that two binomials are factors of a single trinomial.
- ✓ Combine like terms.

KEY VOCABULARY

rectangular array: an arrangement of items in rows and columns

area model: a type of rectangular array, with arranged squares in a grid

area: the size of a surface given in square units: 18 square inches

perimeter: the distance around a two-dimensional shape, given in linear units: 18 inches

factors: two or more numbers that can be multiplied together to get another number (the product): 1, 2, 3, 6, 9, and 18 are factors of 18

expression: a collection of numbers, symbols, and operators put together to show a value (doesn't include equal sign): 3×6

equation: a statement in which the equal sign indicates that two expressions have the same value: $3 \times 6 = 18$

commutative property of multiplication: the mathematical law stating that order doesn't matter in multiplication: $3 \times 6 = 6 \times 3$

distributive property: the sum of two numbers times a third number is equal to the sum of the products of the third number and each of the first two numbers: $3 \times (2 + 4) = 3 \times 2 + 3 \times 4$, or $a(b + c) = ab + ac$

monomial: an algebraic expression with one term: x , x^2 , or $2x$

binomial: an algebraic expression with two terms: $2x + 3$

polynomial: an algebraic expression containing more than two terms: $x^2 + 2x + 1$

ACTIVITY 1

Using Arrays to Explore Multiplication

MATERIALS:

- Images of a carton of eggs, a six-pack of soda, and a 3×4 muffin tin
- 1-inch square tiles, or cut-out paper squares
- How Many Muffins Could You Make? (handout)
- Graph paper (ideally would have a grid on one side, with empty page on the other side)
- (optional) Multiplication Dot Array (handout)

STEPS:

- 1 Tell the class that you are going to show them some photos for only a second or two each and ask them to tell you how many items there are in each photo.
- 2 Flash these images quickly one at a time on a projector or on a printout. After each image, ask *How many? How did you know?*
 - a. carton of eggs
 - b. six-pack of soda
- 3 Show the image of a muffin pan (3×4) on a projector or on a printout. After each image: *How many? How did you know? How is this different from a carton of eggs or a six-pack of soda?* Some students might count each muffin. Show the photo just long enough to see that there are four groups of 3, so that students are encouraged to think in terms of groups.
- 4 Give students the handout HOW MANY MUFFINS COULD YOU MAKE? Ask them to think about the different ways they could express the quantity *12 muffins* mathematically. Possible responses include:
 - $3 + 3 + 3 + 3$
 - $4 + 4 + 4$
 - four groups of 3
 - three groups of 4
 - 4×3
 - 3×4
- 5 With each of these responses, it's useful to go back and ask students to demonstrate how these different “seeings” work. The muffins can be counted in a number of different ways and always end up being 12. You might ask a couple questions to make sure students notice this:

2

This is a way to tap into our students' intuitive understanding of groups. They will know at a glance that there are 12 eggs and 6 sodas. They will probably not know how many sections a muffin tin has, however. Some students will count four groups of 3 or three groups of 4. Other students will count one by one.

4

There are a few important concepts that can be connected to these responses:

- the connection between multiplication and addition—multiplication can represent groups of equal quantities (repeated addition)
- the commutative property (order doesn't matter in addition and multiplication), so 4×3 is the same as 3×4 give the same result

- *Oh, so if I add four groups of 3, that gives me the same as three groups of 4? Can someone explain how that works?*
- *4×3 is the same as 3×4 ? Does that always work? Is 5×4 the same as 4×5 ? 8×3 and 3×8 ? Can I reverse the order of any two numbers when multiplying and get the same answer? Why do you think this works? Give students a few minutes to prove this to themselves.*

TEACHER’S NOTE (EXTRA STUDENT SUPPORT)

With pre-HSE classes, you might spend more time working with dot arrays as a way for students to become comfortable moving from counting dots and adding groups to eventually multiplying to find the quantities. Create a worksheet with different dot arrays involving the multiplication you would like the class to practice. Draw dot arrays on the handout, *How Many Dots Are There?*, to represent different multiplication problems, which students can complete in this way:



(total)

_____ groups of _____

21

(total)

3 groups of 7



(addition)

(multiplication)

7+7+7

(addition)

3 x 7

(multiplication)

ACTIVITY 2 A Measured Area Model

MATERIALS:

- 1-inch square tiles (24 for every two students) • graph paper

We now move from counting objects like eggs, sodas, and muffins to counting more abstract quantities. However, we start in a concrete way by having students use manipulatives to explore the concept of area.

STEPS:

- 1 Put students into groups of two or three. Give 24 one-inch tiles to each pair of students. Tell them that their task is to find how many different ways they can organize the 24 squares into a rectangle. Encourage students to play with the tiles and move them around in different configurations
- 2 Next, hand out graph paper and ask students to draw each of the four rectangles they found: 4×6 , 3×8 , 2×12 , 1×24 . Some students might argue that a 4×6 rectangle is different from a 6×4 rectangle. Take this opportunity to reemphasize the commutative property of multiplication. You can also take a drawing of a 4×6 rectangle and rotate the paper. Does this change the size of the rectangle?

You can find a detailed explanation of the transition from the dot array to the area model for multiplication on EngageNY: <https://www.engageny.org/resource/multiplication-with-arrayarea-models-and-the-rekenrek>

1

Check out the Gold Rush Problem in the Reflective Teaching section for a problem that explores area and can be used to refer back to this activity later.

INTRODUCING AREA

Ask your students what they imagine when you say you want to measure the area of something. If students have ideas, they could include the following:

Length times width.

Perimeter?

Base times height.

Covering something.

Students who make one of the comments on the left are recalling formulas they memorized, possibly without really understanding. Students who say perimeter probably know that there is some relationship between area and perimeter, but might not be sure what the relationship is. A student who says something like “covering something” is on the right track. Have your students note the following definition of area: *size of a surface*. Examples of surfaces include the chalkboard, the tops of student desks/tables, and the walls. A surface can also include contours or bumps, such as a globe or a person’s head. A surface that can be measured using area is something you could imagine painting over. Ask volunteers to submit other real-world examples of area, and ask the class if they agree.

Area is measured in square units (square inches, square feet, square meters). When we measure area, we are essentially counting squares. Perimeter, on the other hand, is a measure of length and is measured in linear units (inches, feet, meters). Instead of counting squares, students should imagine

measuring around their rectangles with a ruler or tape measure. If you wrapped a string around the rectangle, how long would it have to be?

We encourage teachers to help students begin to calculate area by physically counting squares. Kitchen tiles are a good example. Even better, if you have 12-inch square tiles in your classroom, point out to your students how you can measure the area of a section of the classroom floor by simply counting tiles. At this point, it is helpful for them to experience counting squares in order to remember the concept. If they just memorize the procedure of multiplying length times width, it's easy to confuse this with the procedure for finding perimeter.

At some point in the discussion, we hope that a student will remark that the area of any rectangle can be found by multiplying the measures of the two sides. We will want to be precise with this description, so ask some clarifying questions of your students. *Can I find the area by multiplying the lengths of opposite sides? Why doesn't that work?* After this clarification, your students have the ability to find the area of rectangles without a visible grid, and only with the lengths of adjacent sides. Most importantly, they know what the product of the lengths of a rectangle's adjacent sides represents: the number of squares that can cover its interior surface.

- 3 Tell your students to take a few minutes to determine the area and perimeter of each rectangle.
- 4 **Now ask students to describe the rectangles they made.** As volunteers describe each rectangle, draw the rectangle on the board, including the grid lines so that it is possible to count the number of squares in each rectangle. After students have shared their rectangles, ask if we have found all the possible rectangles with 24 squares. *Is it possible that we missed one? How can we be sure?*
- 5 Next ask, *What do you notice about the area and perimeter in these four rectangles?* Possible responses include the following, though you should welcome other observations from your students.
 - The area didn't change, but the perimeter did.
 - It's possible to get the same area with different widths and lengths.
 - 1×24 is one group of 24, 2×12 is two groups of 12, etc.
 - 1×24 , 2×12 , 3×8 , and 4×6 are all equal to 24.
 - The bigger the difference between the two numbers, the larger the perimeter.
 - The closer the two numbers are in size, the smaller the perimeter.

- 6 Before moving on, students should recognize that all of the rectangles on the board have adjacent sides that are factors of 24. Helping students recognize this fact may require a line of questioning that connects the rectangles to factors explicitly.
- *What do all these rectangles have in common?* They all have 24 squares.
 - *How do we know that they all have 24 squares?* We can count them.
 - *Is there any other way we could prove they each have 24 squares?* We could multiply the length and width. 1×24 , 2×12 , 3×8 , and 4×6 all equal 24.
 - *So, the length and width of each of these rectangles (1, 24, 2, 12, 3, 8, 4 and 6) have a relationship with 24. Does anyone know the name for this relationship?* If no one does, tell the group that these numbers are factors of 24 and are usually written in increasing order: 1, 2, 3, 4, 6, 8, 12, 24.
- 7 If it hasn't come up, now is a good time to talk about factors. Amy Vickers uses the following questions with her students:
- What is a factor?
 - How would you explain a factor in the context of rectangular arrays?
 - What are a few examples of numbers that are not factors of 24? How would this look in a rectangular array?
 - What equations can you write to describe the arrays that use multiplication?
 - What equations can you write to describe the arrays that use division?
 - What is the relationship between multiplication and division?
 - For what other math topics is an understanding of factors essential?
- 8 Tell students that you are going to give them a series of multiplication problems that you would like them to show on their graph paper. Start with the following:
- a. 9×4
- Ask students to draw this as a rectangle on their graph paper. They should label the length of the edges and write the area on the inside of the rectangle: *Area = 36 squares.*

b. 12×6

When students finish, ask for volunteers to explain how they came up with 72. Possible responses include:

- *Six groups of 12*
- *Twelve groups of 6*
- *Multiplied 12×6 or 6×12*
- *Multiplied 10×6 and added two groups of 6*

- 9 12×6 is a good opportunity to introduce the distributive property. Draw a 6×12 grid horizontally on the board and tell the class you want to explore the 12×6 further. Make a heavy line dividing the 10 from the 2, to divide the 12 in two pieces. Label the measurements of the edges.

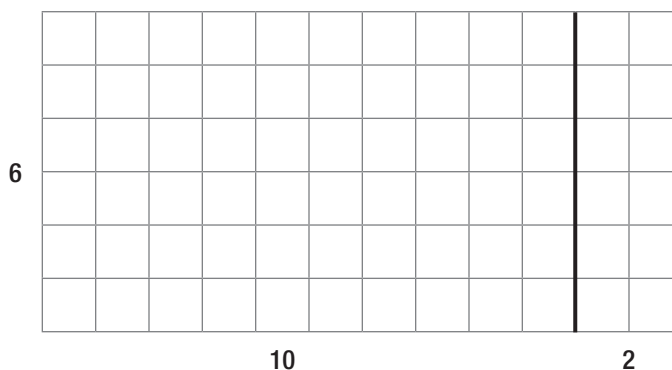

- a. Ask, *Does breaking 12 into 10 and 2 change the total number of squares in the rectangle? How could you prove that we still have the same number of squares?* Possible answers could include:
- *Counting all the squares to see if there are 72*
 - *Adding the 10 and the 2 to make 12, then multiplying by 6*
- b. Ask, *What if we wanted to find the area of the 6×10 rectangle first? How many squares are in that part?* You might block the 2×6 part of the grid so that students can only see the 6×10 rectangle (six groups of ten, ten groups of six, 10×6 , or 6×10). Write the total number of squares in the 6×10 section.
- c. *And what about the right side? How many squares are there?* Block the 6×10 rectangle, so students can only see the 6×2 rectangle (two groups of six, six groups of two, 2×6 , or 6×2). Write the total number of squares in the 6×2 section.

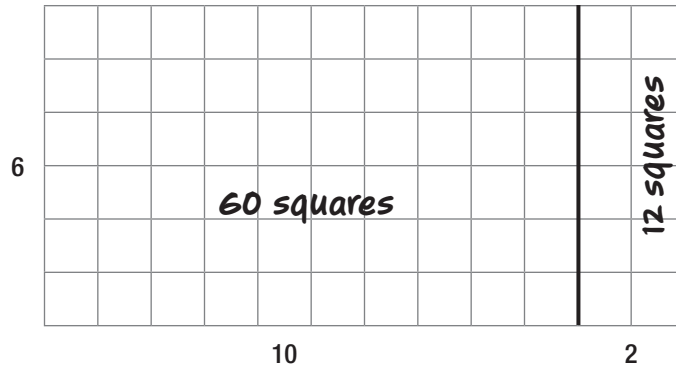

11

This might be a good time to show students how the area model will give the same answer as the standard algorithm for multiplying two-digit numbers. If students are comfortable multiplying multi-digit numbers, they should continue to do multiplication in the way that works for them. The purpose of these activities is not to replace the way they do multiplication, but deepen our understanding of multiplication and connect it to other situations. Challenge: Can you use the area model to explain why the standard algorithm works?

d. So, how many total squares are there? $60 + 12 = 72$.

e. Rewrite the problem on the board as $6(10 + 2) = 72$. Ask students to explain how this equation connects to the area model drawn on the board.

10 At this point, students should continue using area models to calculate the number of squares with some problems on their own. Say, *On your own, try using this model to multiply 15×9 . After you draw your big rectangle, break the side that is 15 squares long into 10 and 5, then use the same method that we just did for 12×6 .*

- 15×9
- 18×4
- 24×5
- 14×15

11 To process 14×15 , guide students to break the 14 into 10 and 4, and the 15 into 10 and 5. Students should end up with a grid similar to the one below and then calculate the area of each of the four sections ($4 \times 5 = 20$, $4 \times 10 = 40$, $10 \times 5 = 50$, $10 \times 10 = 100$)

How could we figure out the total area?

Answer: Add up the total squares for each section ($20 + 40 + 50 + 100 = 210$).

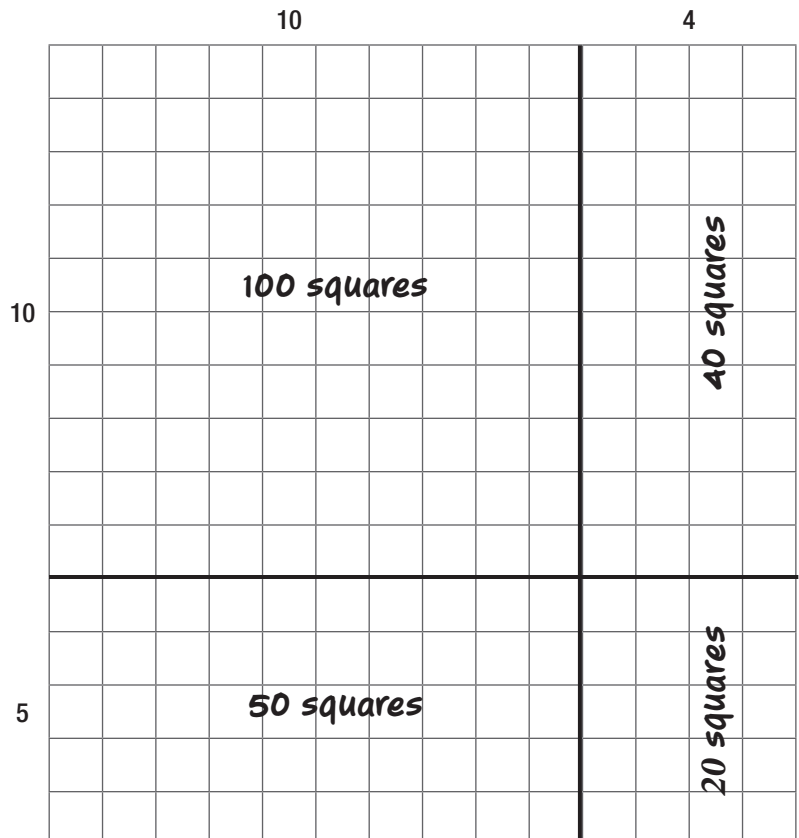

ACTIVITY 3 The Distributive Property

MATERIALS:

- **Multiplying with Parentheses (handout)**

This is a great moment to teach the distributive property of multiplication, using the previous work as an example. This concrete example of distribution will help students remember that they need to multiply by each term within parentheses.

The handout **MULTIPLYING WITH PARENTHESES**, can be used to explore the distributive property with students:

- 1 Say, *What does it mean to simplify an expression? Can someone explain the steps that Paul took when he simplified $5(3 + 12)$? What do you think of what he did? Would you do it differently or the same way? What is Paul's confusion?*
- 2 Ask a student to draw an area model of the expression on the board.
- 3 Ask, *How can the area model help us understand $5(3 + 12)$?*
- 4 Students should be able to connect their explanations to the drawing. Some students may previously have known the distributive property, but they should be able to explain why calculating the area of both rectangles is necessary to find the total squares.

ACTIVITY 4 An Abstract Area Model

After students have practiced and become comfortable using the concrete method of counting squares using grid paper, we can move to an abstract area model by leaving the grid paper behind.

- 1 Give the class a multiplication problem whose area model won't fit on their graph paper, like 45×26 . You might count the number of rows or columns on the graph paper you give them and then choose a number that is just a little bit too big. Students will try to count out the rows and columns. When students realize that they aren't able to use the grids, tell them to turn the paper over and do it on the back.
- 2 Let your students know that they don't have to draw all the lines in the grid. They can just draw a rectangle. Ask your students to use the same technique for breaking up the numbers and drawing lines to divide the rectangle. Here's one way a student might break up the rectangle and calculate the area for each section.

	40	5
20	<i>800 squares</i>	<i>100 sq.</i>
6	<i>240 squares</i>	<i>30 sq.</i>

- 3 Next to the area model, show the calculations for the area of each of the smaller rectangles, as well as the total area:

$$6 \times 5 = 30$$

$$6 \times 40 = 240$$

$$20 \times 5 = 100$$

$$20 \times 40 = 800$$

$$\text{total area} = 1170 \text{ squares}$$

- 4 You can use this opportunity to make connections to the standard way of doing multiplication in the United States. Ask students to look at the following two models and make connections to the area model. The image to the right shows the standard algorithm on the left and the partial product method on the right. Students will probably be familiar with the standard algorithm, though students often struggle to record products with the proper place value. The partial product method separates the calculations and retains the place value for each. The second line, for example, shows the product of 6 and 40, rather than multiplying 6 and 4 as part of the multiplication of 45 times 6.

$\begin{array}{r} 45 \\ \times 26 \\ \hline 270 \\ 900 \\ \hline 1170 \end{array}$	$\begin{array}{r} 45 \\ \times 26 \\ \hline 30 \\ 240 \\ 100 \\ 800 \\ \hline 1170 \end{array}$
--	---

What do your students notice about how the totals are calculated and arranged? Where do they see any connections to the area model of multiplication? Which of these procedures for multiplication do they prefer? Does anyone think they might use the partial product method in the future?

4

A clear demonstration of the partial product algorithm can be found at <http://everydaymath.uchicago.edu/teaching-topics/computation/mult-part-prod/>.

ACTIVITY 5

Applying the Area Model to the Multiplication of Polynomials

In order to start working with binomials and polynomials, it is important for students to understand and be able to use the distributive property. The area model gives students a way to organize their work. When they move on to college, we will want them to be able to use FOIL (First, Outside, Inside, Last) as well, but starting with the area model connects an abstract idea to a concrete model that students can hold on to. We continue by substituting variables into the area models we have already worked on so that students see the continuity in the approach. We follow the same logic as before, but now we apply it to expressions that include variables.

- 1 As a review, draw an abstract area model of $6(10 + 2)$. Students should be able to say that the total number of squares is $(6 \times 10) + (6 \times 2)$.
- 2 To the right, draw an area model of $6(x + 2)$.

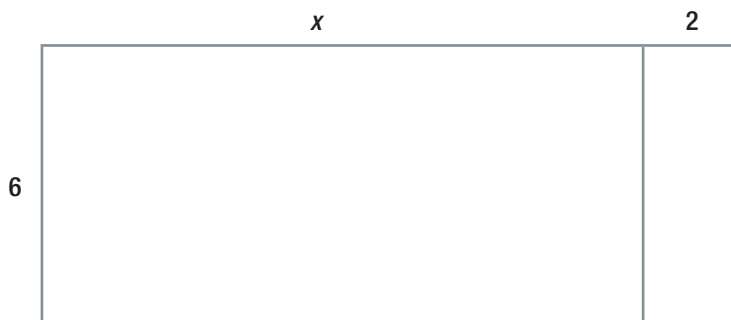

If students are unfamiliar with variables, you can say that x just means we don't know the width of the rectangle on the left. Even though we don't know how wide it is, we do know that 6 times that width would tell us how many squares there are in the left part of the rectangle. If x was 2, then there would be 12 squares. If x was 3, there would be 18 squares. If x was 100, there would be 600 squares. x could be anything.

- a. Ask students what the area of the rectangle on the right would be. *Answer:* 12 squares.

And the area of the rectangle on the left? *Answer:* 6 times x , or $6(x)$, or $6x$ squares. $6x$ is a way of saying that even though we don't know how many squares are there, we do know that there will be 6 times whatever x is.)

Write $6x$ and 12 inside the rectangles.

- b. Below the area model, write $6(x + 2) = 6x + 12$.
- c. Following the model on the board, students should practice multiplying the pairs below, drawing area models and writing expressions for their answers:

- (1) 9 and $(x + 5)$
- (2) 4 and $(x + 8)$
- (3) 5 and $(2x + 4)$

3 For a second example, tell the class to draw an area model of $(x + 5)(x + 4)$. Their model should look like this:

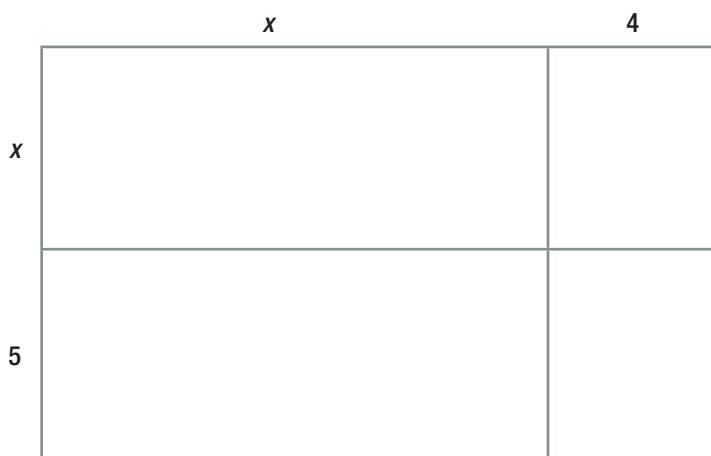

- a. Ask students to help you fill in the area of each rectangle, starting with the bottom right one ($4 \times 5 = 20$ squares). Now, move to the top right and bottom left rectangles. Students should be able to fill in the area of these rectangles with $4x$ and $5x$, respectively. The top-left box may present a challenge for students who haven't studied square numbers or exponents. At the beginning, I would accept the following answers: x times x , or x times itself, $x \times x$, and, eventually, x^2 .

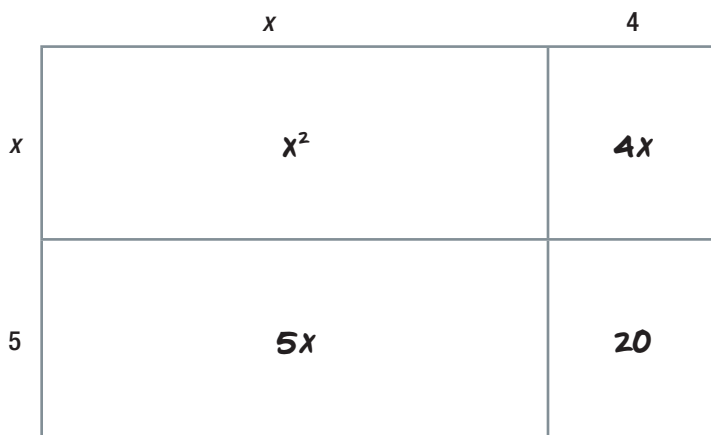

3a

This is a good opportunity to talk to students about how x is not generally used to mean multiplication in algebra. Students should start to recognize multiplication in the following forms:

$$5 \cdot 6 = 30$$

$$5(6) = 30$$

In this case, we want to express that x is multiplied by x . Do students see how using x to represent multiplication might cause a problem?

3b

You can define term as either a single number or variable, or numbers and variables multiplied together. The areas x^2 , $4x$, $5x$, and 20 are all examples of terms.

- b. Below the area model, write $(x + 5)(x + 4) = x^2 + 4x + 5x + 20$.
- Ask the class if there is anything you can do to simplify the equation, or write it with fewer terms. If no one brings up combining the **terms** $4x$ and $5x$, explain that, in algebra, we can combine items when the variable parts are the same (*combining like terms*). Ask the class to point out which two terms have the same variable part. These two terms can be combined. If we have 4 x 's and 5 more x 's, then we must have 9 x 's altogether.
 - Write $(x + 5)(x + 4) = x^2 + 9x + 20$ below the first equation.
 - Prompt the class to look at the expression $x^2 + 9x + 20$ and think about how it connects to the area model. Here are some questions you can ask:
 - *Where does the x^2 come from?*
 - *Where does the $9x$ come from?*
 - *Where does the 20 come from?*

Here, we want students to see the connection between the product and sum of 4 and 5, as they appear in the polynomial that is the product of the two binomials.

- *Do you see any connections between 9 and 20? What is interesting about these two numbers?*
- *Look at the area model. How did we get 9? $4 + 5$. How did we get 20? 4×5 . Hmm... What do you think about that?*
- *So, $4 + 5$ is 9 and 4×5 is 20. That's interesting. Do you think that would happen if we multiplied other quantities? Let's do some other ones and see if it happens again.*

- 4 Give students practice multiplying binomials. Some samples you could use are:

$$(x + 1) \text{ and } (x + 2)$$

$$(x + 3) \text{ and } (x + 4)$$

$$(x + 2) \text{ and } (x + 5)$$

- a. At this point, you could come back to the connection between the x term and the constant. Ask students to look at the trinomial expressions that were products of the binomials they multiplied. Ask, *What do you notice about the x term and the constant?* If there are students who don't see the connection, you might do a quick pair/share and ask students to discuss the following example:

$$(x + 3)(x + 4) = x^2 + 7x + 12$$

- b. Then put this example on the board:

$$(x + 2)(x + 5) = x^2 + 7x + 10$$

Ask for volunteers to talk about what they notice when they compare these two examples. When students have confirmed that the constants from the two binomials are added to get the x term in the trinomial and multiplied to get the constant in the trinomial, you might give them the attached diamond pattern worksheets that will prepare them for factoring polynomials.

4a

You can define the constant as a term in an algebraic expression that has a value that doesn't change, because it doesn't have a variable.

MAKING YOUR OWN NUMBER DIAMOND WARM-UP (OPTIONAL)

As you create your own number diamond problems, rotate the given information so that students have to adjust their reasoning. Include decimal examples, particularly those that help students practice their mental math strategies, and that include the benchmark decimals (0.5, 1.5, 2.5, etc.). Be careful about items that only include the product and sum—these can be difficult when decimals are involved. Have fun!

How Many Muffins Could You Make?



How many different ways can you express the number of muffins that this pan holds?

Multiplication Dot Array

How Many Dots Are There?

(total)

_____ groups of _____

(addition)

(multiplication)

(total)

_____ groups of _____

(addition)

(multiplication)

(total)

_____ groups of _____

(addition)

(multiplication)

(total)

_____ groups of _____

(addition)

(multiplication)

Multiplying with Parentheses

Paul's teacher wrote the following expression on the board for the class to simplify:

$$5(3+12)$$

Here is an excerpt from Paul's notebook.

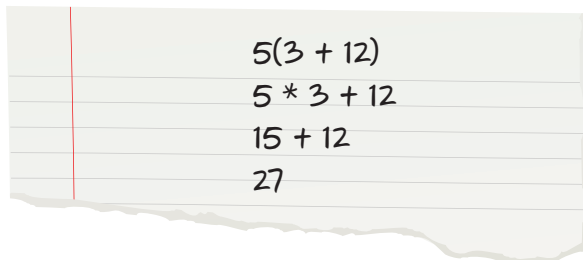
$$\begin{array}{l} 5(3 + 12) \\ 5 * 3 + 12 \\ 15 + 12 \\ 27 \end{array}$$

What do you think of Paul's work? Explain your thinking.

Draw an area model of $5(3+12)$ below:

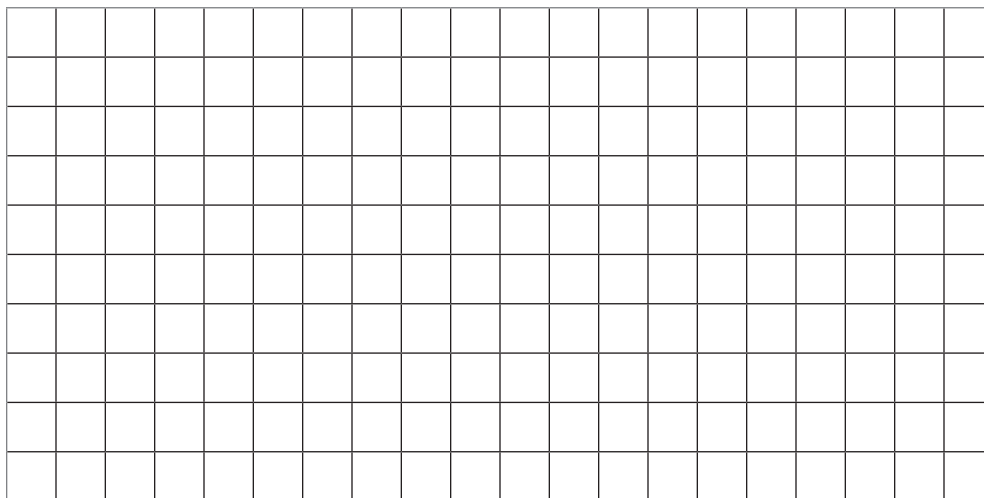

How many squares are there?

Number Diamond 1

A Number Diamond always includes four circles. The two horizontal circles are our two base numbers. The top circle is for the product of the two base numbers. The bottom circle is for the sum of the two base numbers.

In each Number Diamond, you will be given two numbers, and you will have to figure out the missing two. In this example, you are given the two base numbers. What is the product of 3 and 6? What is the sum of 3 and 6?

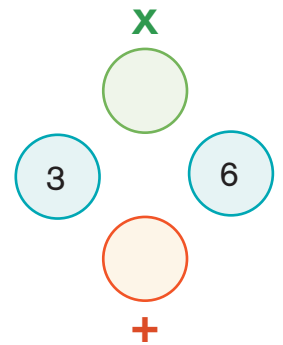

Fill in the missing circles for each Number Diamond.

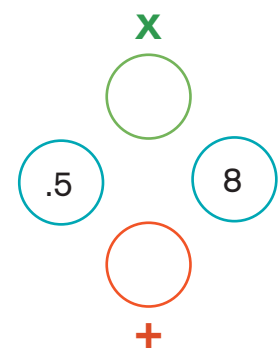
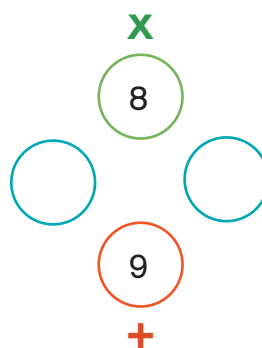
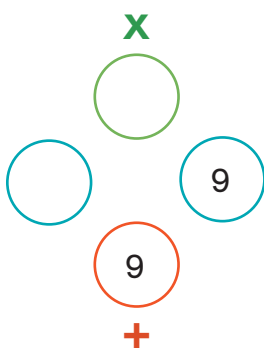
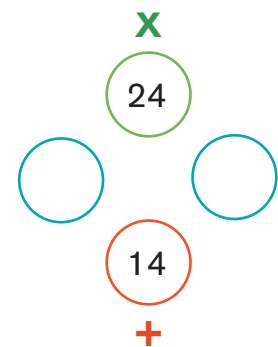
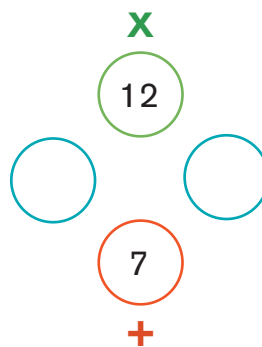
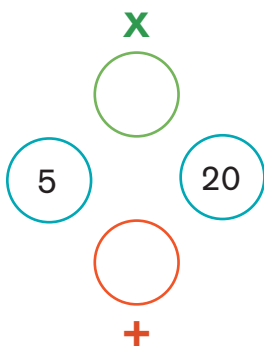
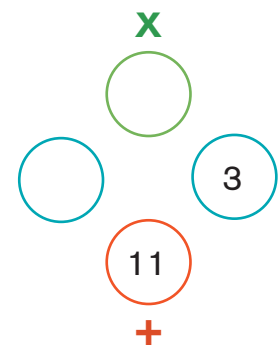
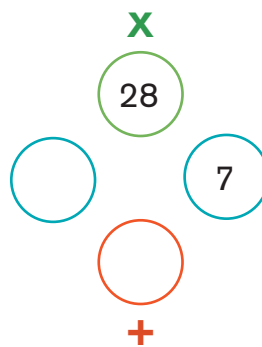
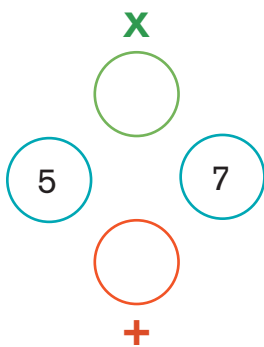

Source: Adapted from *Foundations for Algebra* by College Preparatory Mathematics

Solution: Number Diamond 1

These number puzzles provide a rich and engaging opportunity for students to improve their arithmetic skills, including whole numbers, decimals, fractions, and even negative numbers.

These puzzles also foreshadow skills students will need if they go on to college-level mathematics. This particular type of factoring requires the kind of reasoning called for when students need to figure out the base numbers when given their product and sum.

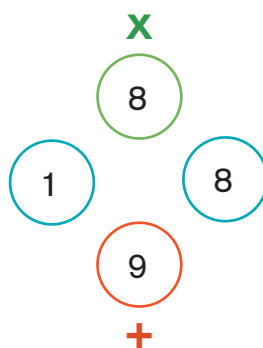
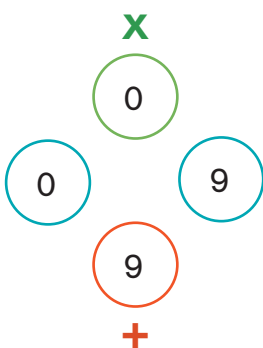
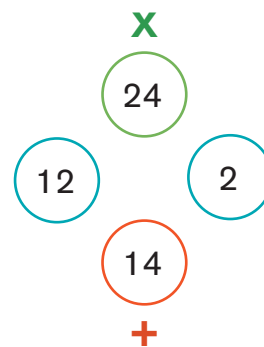
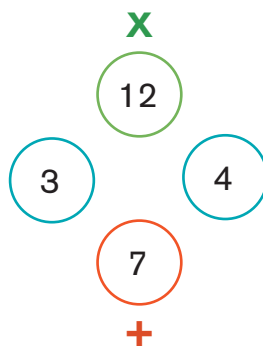
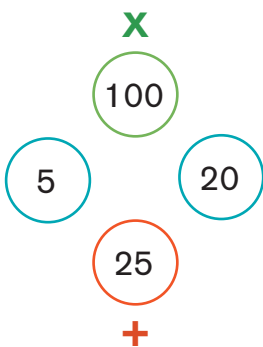
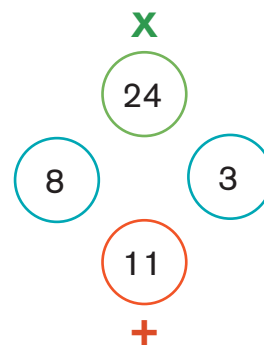
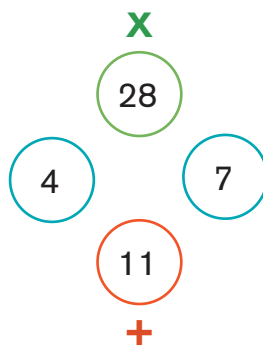
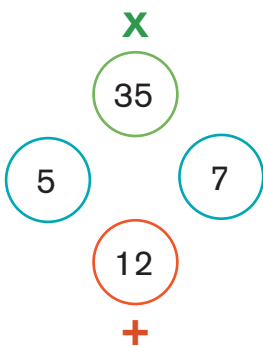

Source: Adapted from *Foundations for Algebra* by College Preparatory Mathematics

Number Diamond

Fill in the missing circles for each Number Diamond.

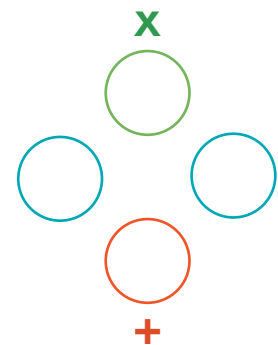
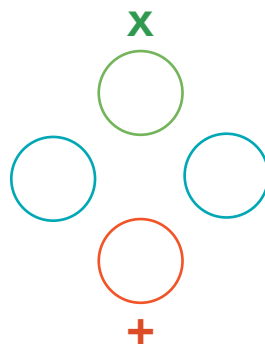
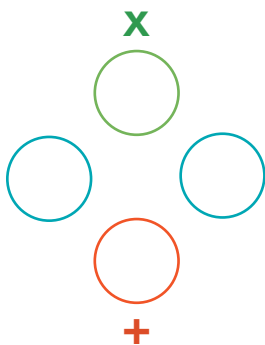
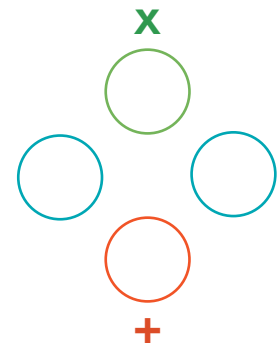
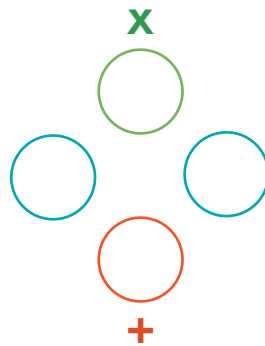
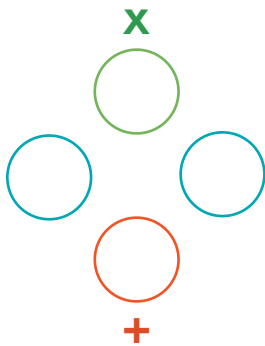
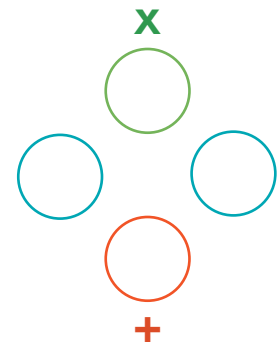
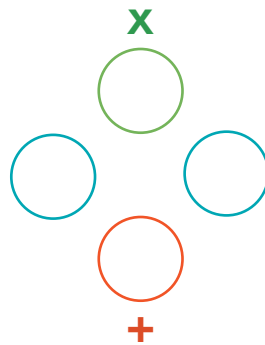
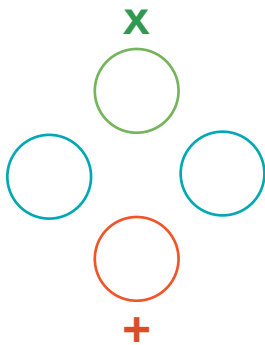
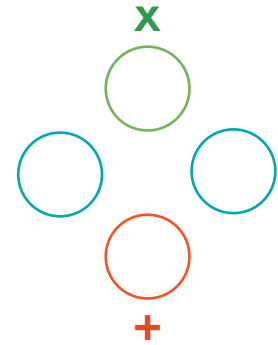
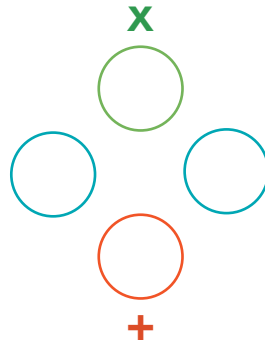
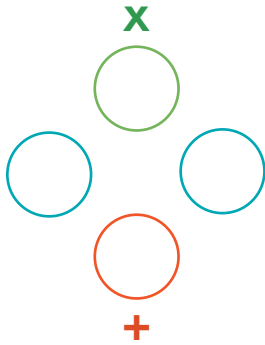

Source: Adapted from *Foundations for Algebra* by College Preparatory Mathematics

“What would it look like if we designed schools to be places where teachers learned, alongside their students?”

—Dr. Elham Kazemi

Reflective Teaching

A Focus on Student Thinking in Problem-Solving

If there is one mantra that has stuck with us when it comes to improving our math instruction, it is “make a small change, reflect, and do it again.” In their article, “Math Tasks as a Framework for Reflection: From Research to Practice,” Mary K. Stein and Margaret Schwan Smith cite the NCTM Professional Standards for Teaching Mathematics which argue that a primary factor in the professional growth of teachers is the opportunity teachers have to “reflect on learning and teaching individually and with colleagues.” They go on to say that whereas all teachers informally think about what happens in their classrooms, “cultivating a habit of systematic and deliberate reflection may hold the key to improving one’s teaching as well as to sustaining lifelong professional development.”

But what should teachers reflect on? There is no right answer to that question, but we’d like to share some work we’ve been doing to support teacher reflection, focusing on student mathematical thinking on nonroutine math problems.

Below you will find three sets of questions focusing on three important aspects of your teaching—planning, student work, and reflection/revision. The goal of these questions is to help you learn from your experience and from the experience of your students. I recently heard an inspiring question from **Dr. Elham Kazemi**, professor of mathematics education and associate dean for professional learning at the University of Washington—“*What would it look like if we designed schools to be places where teachers learned, alongside their students?*” We offer the process detailed below as a beginning. Even if you only have time to answer a few questions from each section, or if you only do this formally once a year, we hope the experience will be rewarding.

You are a scientist looking into learning. The planning phase is your problem-posing and hypothesizing. The teaching is the experiment, and the student work is the data collection and observation. The reflection is the conclusion and may lead to a revised hypothesis and a new “teaching experiment.”

One final suggestion... Consider doing this with at least one other teacher. You can do a problem together and then work together on the Planning Questions. Then each of you tries the problem with their students. You can meet again and discuss what you learned from your students’ reasoning. These questions can help structure any follow-up conversations.

**Make a
small change,
reflect, and
do it again.**

Dr. Kazemi has developed a great observation technique called “teacher time out.” To learn more, visit <http://www.shadowmathcon.com/elham-kazemi/>

Instructions

- 1 Find or create an open-ended, challenging math problem that meets the criteria proposed in the introduction to the math section.
- 2 Complete the **Planning Questions** below, before doing the problem with your class.
- 3 Try the problem with your students.
- 4 Collect samples of student work.
- 5 Choose some samples of student work and complete **Questions on Student Work**.
- 6 Complete the **Reflection/Revision Questions**.

PLANNING QUESTIONS

We start with a quality math problem and try to solve it in as many ways as possible. Once we have had our own problem-solving experience with the problem, we can be explicit about the content/strategies we want students to learn. Then we start to think about how to engage students. We can begin to imagine how students might approach the problem. We can also start to identify potential student struggles and plan for them beforehand. One of our goals is to allow students to experience productive struggle and that requires some preparation. It can be hard to come up with questions to support struggling students and extensions to challenge faster learners if we have to do it in the moment. Certainly, we are always going to have to do some thinking on our feet, but the better prepared we are, the more strategic we can be.

- 1 Describe how you solved the problem.
- 2 Can you think of any other ways to solve the problem?
- 3 Why did you choose this problem? What do you like about it?
- 4 Why do you think this is a DOK 3 problem?
- 5 What do you want students to get from working on this problem?
- 6 Identify and describe a few specific challenges you think students will have in solving the problem. Describe how you might help and support the problem-solving efforts of those students without giving too much away.
- 7 How could you extend this problem for students who finish?

QUESTIONS ON STUDENT THINKING

Adult education teachers always talk about how much we learn from our students. Many teachers say they learn more from their students than their students learn from them. Teachers are usually referring to all the stories and experiences our students share, or the inspiration we derive from their decisions to come to our classes, balancing complicated lives and responsibilities for a regular date with struggle. But there is another really important way we can learn from our students—focus on their reasoning. We must really delve deeply into student thinking, to understand the individuals in our class, and also to better understand adult education students in general and how they learn. Our students are trying to teach us, if we take the time to listen. If possible, consider doing this phase with another teachers. Math teachers coming together to analyze student thinking can be a rich activity. Remember when choosing work to analyze, don't focus only on students who got the right answer. You may learn more from student mistakes, or solution methods that are interesting but incomplete.

**Our students
are trying
to teach us
if we take the
time to listen.**

Answer the following questions for each sample of student work you choose:

- 1 Explain each student's method/thinking.
- 2 Why did you choose this sample of student work?
What did you learn from it?
- 3 How typical was this student's approach in your class?
- 4 Any additional comments?

REFLECTIONS/REVISION QUESTIONS

Whatever happens is an opportunity to learn something about your students and how they learn. If something doesn't go well, you can learn a lot about how to do it better next time. And if things do go well, why did they go well and how could they go better. This section is about looking back at your predictions and comparing them to what happened—as you observe and analyze student thinking you'll start to improve your sense of how they will make sense of and productively struggle with future problems. Even if you are not going to be sharing this with other teachers, spend some time with the last question. The teacher you are advising might be you.

- 1 What did you learn from using this problem with your students (about math, about individual students, about your class, about student thinking in general, etc)?
- 2 What (if anything) would you do differently if you used this problem again?
- 3 Comment on how your class (individual students, or as a whole) may have benefited from their work on this problem.
- 4 Did students get what you wanted them to get from the problem? How do you know?
- 5 What challenges came up for your students that you didn't expect?
- 6 What strategies/solution methods/questions came out that seemed helpful to students?
- 7 What advice/message do you have for a teacher who is considering using this problem with their class?

MathMemos.org is a teacher space where adult numeracy/HSE teachers share rich math problems, samples of student work, and practical suggestions for bringing the problem to life in your classroom. MathMemos contributors are adult educators who are passionate about teaching math through problem-solving activities.

A Call to Action

To give readers a real sense of how helpful these reflections can be, we are including three sample write-ups, written by Tyler Holzer, a teacher leader at a community-based organization in Brooklyn, NY. If you find Tyler's write-ups helpful, consider writing one yourself, using these questions to guide you. Share those write-ups with your colleagues. Write them with your colleagues. If you are a program manager, consider protecting some time for your staff to work on these questions together. We believe in teacher-led professional development of practice. Too often, we teach in our little pocket of the egg carton, isolated from other teachers. Let us turn our classrooms into laboratories to learn about learning and share what we discover.

- Multiples of Nine Problem
- The Gold Rush Problem
- The Movie Theater Problem

Multiples of Nine Problem

The Problem:

Find the smallest multiple of 9 that has only even digits. Please show all your work.

How I Solved It

I knew that none of the two-digit multiples of 9 contained only even numbers. I also knew that any multiples of 9 that were between 100 and 199 wouldn't work, because they all would have a 1—an odd number—as the leading digit. I started working under the assumption that the correct number would be somewhere in the 200s, so I picked a nice, round number and started from there. I calculated $9 \times 30 = 270$. Because this had a 7 in it, I knew that it couldn't be the right answer, but I noticed that if I were to add 18 to 270, I would get 288. Thus, $9 \times 32 = 288$ was my tentative answer.

I couldn't commit to this answer because there might be a smaller multiple of 9 that was located in the 200s and also had only even digits. So I went back to 270 and began counting down by 18. I counted down by 18 instead of 9 because the correct number has to be an even number times 9 (so that I would have an even product). So the numbers I checked were $9 \times 28 = 252$, $9 \times 26 = 234$, and $9 \times 24 = 216$. None of these worked, so the correct answer must be 288.

Other Ways to Solve This Problem

I could just write out all the multiples of 9 and keep going until I found one that had only even digits. This method feels a little risky because—if I were just counting up by 9 to the next multiple rather than multiplying each time—it would be easy to make a mistake somewhere. Even if I were to go through and multiply 9 by several numbers, it's likely that I would miss a number at some point.

Another way to solve this involves knowing the divisibility test for 9. If the sum of the digits in a number add up to a multiple of 9, then the number itself is divisible by 9. The sum of the digits in this problem couldn't be 9, though, because the sum of even numbers can never be odd. The smallest multiple of 9 with only even digits must be the smallest combination of three even numbers that add up to 18. It would have to be 288.

Also, when the multiples of 9 are organized into a table, an interesting pattern emerges. By looking at the digit sums and the changes to the ones and tens digit, we see some interesting things.

Table of the First Forty Multiples of 9			
$9 \times 1 = 9$	$9 \times 11 = 99$	$9 \times 21 = 189$	$9 \times 31 = 279$
$9 \times 2 = 18$	$9 \times 12 = 108$	$9 \times 22 = 198$	$9 \times 32 = 288$
$9 \times 3 = 27$	$9 \times 13 = 117$	$9 \times 23 = 207$	$9 \times 33 = 297$
$9 \times 4 = 36$	$9 \times 14 = 126$	$9 \times 24 = 216$	$9 \times 34 = 306$
$9 \times 5 = 45$	$9 \times 15 = 135$	$9 \times 25 = 225$	$9 \times 35 = 315$
$9 \times 6 = 54$	$9 \times 16 = 144$	$9 \times 26 = 234$	$9 \times 36 = 324$
$9 \times 7 = 63$	$9 \times 17 = 153$	$9 \times 27 = 243$	$9 \times 37 = 333$
$9 \times 8 = 72$	$9 \times 18 = 162$	$9 \times 28 = 252$	$9 \times 38 = 342$
$9 \times 9 = 81$	$9 \times 19 = 171$	$9 \times 29 = 261$	$9 \times 39 = 351$
$9 \times 10 = 90$	$9 \times 20 = 180$	$9 \times 30 = 270$	$9 \times 40 = 360$

Why I Chose This Problem

I recently discovered this problem, and I really like it for a number of reasons. First, it requires a little bit of vocabulary in order to get started. Students will have to know what a multiple is, they will have to know what digits are—and more specifically, how digits can differ from numbers—and they’ll have to understand the difference between even and odd numbers. I also like how nonintimidating it looks at first glance. “How hard could it be to find a multiple of 9 that has only even digits? I shouldn’t have to count up very far.” Because the problem doesn’t look lengthy or challenging, it comes as a surprise when the correct answer is actually the 32nd multiple of nine. I anticipate a lot of students writing out 9, 18, 27, 36, 45, 54, etc, and then getting frustrated or giving up when they don’t get to the answer fairly quickly.

Second, I like that the problem requires students to perform basic calculations and that it requires precision in order to get the answer right without making mistakes. Also, the repetition involved in either adding 9 over and over or multiplying by 9 over and over is helpful for students with lower math abilities, and it still provides good practice for students who are more comfortable working with numbers. Moreover,

the 9 times tables are interesting because of the pattern that arises in the tens digit and the ones digit. My hope is that as students start listing out the multiples of 9, they will be able to see the pattern and work with it. I like exposing my students to several different ways of thinking about multiplication. My hope is that they find one that works for them.

And finally, I really like this problem because there are good extension questions. If a student finishes early, they can find the next smallest multiple, and then the next one. Once everyone has had plenty of time to work, the class can talk about divisibility tests, and they could work on finding all the three-digit multiples of 9 that have only even digits. And so on.

Why This Is a DOK 3 Problem

This is a DOK 3 problem because it invites multiple approaches, and even though there is a correct answer, students need to be able to explain why the number they chose is the correct one. They also have to analyze each multiple they come up with to make sure that both digits are even. (I anticipate several students saying that something like 36 or 72 is correct because it is an even number.) Depending on how quickly students finish, they might be asked to investigate the pattern that shows up in the multiples of 9 that only have even digits. Students could then be asked to draw a conclusion about that pattern.

My Goal for Student Learning

This problem is intended for a class of new students with low math levels, many of whom struggle with multiplication, and it is going to take a while for most of them to finish. My goal is for them to stick with the problem and not get discouraged as the numbers start getting bigger and bigger. I am giving this problem during the first week of class, and my sense is that the students aren't used to struggling with math problems for long periods of time. Another goal is for students to come up with an organized approach to tackling this problem. That is, I would like to see some students create tables or lists rather than simply start multiplying 9 by randomly chosen numbers. Also, because it's so early in the cycle, I would like to see my students feel comfortable talking about their work and the work of their peers.

Challenges for Students

The first challenge I anticipate involves the vocabulary and phrasing of the problem. Because I will be working on this problem with a group of new students, they have only recently been introduced to multiples and factors. They will likely need a quick refresher. Similarly, I expect to see

students struggle with the idea of “even digits,” and we may have to talk about it as a group to make sure that everyone is on the same page before we get started.

I also expect students to have a hard time organizing their work, and I expect to see some mistakes with basic computation as the multiples get higher and higher. This will require me to intervene somewhat to help students spot their mistakes—either with adding or multiplying, depending on their approach. I think that some students will want to give up after they’ve found the first fifteen or twenty multiples of 9. They might think that it’s a trick question and that there actually aren’t any multiples of 9 that have only even digits.

To support students who are struggling with this problem, I will help them identify mathematical mistakes so that they can correct them as they go along. I won’t tell them that they’ve made a mistake though; instead, I’ll ask them to talk about how they got from one number to the next so that they can see the mistake for themselves. I think that some students will notice the pattern in multiples of 9 (increasing tens digit, decreasing ones digit), and so I will help them to articulate it and apply it to the work that they are doing. For those students who work all the way through it and don’t see the pattern, I will ask them to look over their work and talk to me about the changes they see to the digits. I expect that some students will try to guess-and-check their way through the problem, which could potentially make it take a very long time. I will talk to these students about ways they might be able to organize their guesses so that they don’t lose track of the work they’ve already done.

Extension Questions

If some students finish early, I would ask them to find the next smallest multiple of 9 with only even digits, and then the next one, and the next one, and so on. It might seem a little tedious at first, but if I support it well, I can help students to understand how the divisibility test for 9 works. This is something that I don’t think many, if any, students will know.

All of the multiples of 9 that are less than 1000 and have only even digits are: 468, 486, 648, 666, 684, 828, and 882. Even if a student only got to 468 and 486, I could start having the conversation with them about how any number with a digit sum equal to a multiple of 9 must itself be a multiple of 9. Since no combination of even numbers can sum to 9, they must have to sum to 18. From there, students can work on finding the other possibilities.

Student Work

FIDEL'S APPROACH

Fidel is one of the strongest students in this group. He attends every class session, asks good questions, and works hard on every problem that he encounters. Even this early in the cycle, Fidel's classmates have come to recognize him as one of the leaders in the class, and they often rely on him to help them out when they are struggling. However, Fidel had a really hard time with this problem.

First off, he needed a reminder on the difference between odd and even numbers, and after we talked about it as a group, he wrote them down just to be sure. Then he started working. If you look closely at Fidel's work, you'll see that he started out by writing all of the multiples of 9, but then he erased them. When I asked why, he explained that when he got above 100, he noticed that all of the multiples would have a 1 in them and therefore couldn't be correct. This is where he gave up on the list and decided to try guessing and checking. His guesses look a little disorganized, but there is a method to them. He was trying to locate multiples of 9 that were in the 200s. His first guesses were much too big, but he kept making adjustments. He erased most of these, but he left a few and, after a while he found $9 \times 32 = 288$.

What was interesting about Fidel's work is how he noticed some important qualities about the numbers—namely, that the correct answer would have to start with a 2, 4, 6, or 8—but he didn't come up with a good way of organizing the work that he was doing. Because he guessed and checked, several students finished the problem before him and began working on the extension questions. This was a case where the strongest student in the class struggled the most because the problem-solving strategy he chose may not have been the most appropriate one.

JEAN MARIE'S APPROACH

Of all the students in the class, Jean Marie probably has most difficulty with math. She performs all basic calculations on her fingers, and she has little confidence in her ability to grow as a math student. This was the first extended problem that she had done on her own.

From the outset, Jean Marie was frustrated by this problem because she noticed that it had to do with times tables, and she reminded me several times that she doesn't know her nines. You'll even see at the top of the page that she was drawing circles for the first couple multiples of 9. While everyone else was working on their own, I spent a lot of time sitting with Jean Marie and talking her through the problem. She

Student Work

Odd Numbers - 1, 3, 5, 7, 9
 Evens Number - 2, 4, 6, 8, 0

$9 \times 1 = 9$	$9 \times 21 = 189$
$9 \times 2 = 18$	$9 \times 22 = 198$
$9 \times 3 = 27$	$9 \times 23 = 207$
$9 \times 4 = 36$	$9 \times 24 = 216$
$9 \times 5 = 45$	$9 \times 25 = 225$
$9 \times 6 = 54$	$9 \times 26 = 234$
$9 \times 7 = 63$	$9 \times 27 = 243$
$9 \times 8 = 72$	$9 \times 28 = 252$
$9 \times 9 = 81$	$9 \times 29 = 261$
$9 \times 10 = 90$	$9 \times 30 = 270$
$9 \times 11 = 99$	$9 \times 31 = 279$
$9 \times 12 = 108$	$9 \times 32 = 288$
$9 \times 13 = 117$	$9 \times 33 = 297$
$9 \times 14 = 126$	$9 \times 34 = 306$
$9 \times 15 = 135$	$9 \times 35 = 315$
$9 \times 16 = 144$	
$9 \times 17 = 153$	
$9 \times 18 = 162$	
$9 \times 19 = 171$	
$9 \times 20 = 180$	

started with $9 \times 1 = 9$ but then couldn't remember 9×2 . So we talked about how she would figure it out. She seemed a little embarrassed when telling me that she would count on her fingers. But when I told her that her method was fine, she went back to work. She counted up to 18, and then counted up another 9 to 27, and so on. From here, she was able to work on her own, but she tried to give up about every five minutes. It took a lot of encouragement to get Jean Marie through this problem, and she made a lot of mistakes. I made the decision to help her identify her mistakes so that she wouldn't get more frustrated as she got further and realized she had been working with incorrect numbers.

In the end, with a lot of support, Jean Marie did arrive at the correct answer. I liked how well-organized her method was, and I really appreciated her ability to stick with a problem that was so challenging and frustrating to her. In the end, Jean Marie finished before Fidel did! And it was a really important moment for her. She wrestled with a problem that she thought she could never do, and she was successful.

Student Work

Multiples of Nine

Find the smallest multiple of 9 that has only even digits. Please show all your work in the space below.

18, 36, 54, 72, 90, 108, 126, 144, 162, 180, 198, 216, 234, 252, 270, 288, 306, 324, 342, 360, 378, 396, 414, 432, 450, 468, 486, 504, 522, 540, 558, 576, 594, 612, 630, 648, 666, 684, 702, 720, 738, 756, 774, 792, 810, 828, 846, 864, 882, 900, 918, 936, 954, 972, 990, 1008, 1026, 1044, 1062, 1080, 1098, 1116, 1134, 1152, 1170, 1188, 1206, 1224, 1242, 1260, 1278, 1296, 1314, 1332, 1350, 1368, 1386, 1404, 1422, 1440, 1458, 1476, 1494, 1512, 1530, 1548, 1566, 1584, 1602, 1620, 1638, 1656, 1674, 1692, 1710, 1728, 1746, 1764, 1782, 1800, 1818, 1836, 1854, 1872, 1890, 1908, 1926, 1944, 1962, 1980, 1998, 2016, 2034, 2052, 2070, 2088, 2106, 2124, 2142, 2160, 2178, 2196, 2214, 2232, 2250, 2268, 2286, 2304, 2322, 2340, 2358, 2376, 2394, 2412, 2430, 2448, 2466, 2484, 2502, 2520, 2538, 2556, 2574, 2592, 2610, 2628, 2646, 2664, 2682, 2700, 2718, 2736, 2754, 2772, 2790, 2808, 2826, 2844, 2862, 2880, 2898, 2916, 2934, 2952, 2970, 2988, 3006, 3024, 3042, 3060, 3078, 3096, 3114, 3132, 3150, 3168, 3186, 3204, 3222, 3240, 3258, 3276, 3294, 3312, 3330, 3348, 3366, 3384, 3402, 3420, 3438, 3456, 3474, 3492, 3510, 3528, 3546, 3564, 3582, 3600, 3618, 3636, 3654, 3672, 3690, 3708, 3726, 3744, 3762, 3780, 3798, 3816, 3834, 3852, 3870, 3888, 3906, 3924, 3942, 3960, 3978, 3996, 4014, 4032, 4050, 4068, 4086, 4104, 4122, 4140, 4158, 4176, 4194, 4212, 4230, 4248, 4266, 4284, 4302, 4320, 4338, 4356, 4374, 4392, 4410, 4428, 4446, 4464, 4482, 4500, 4518, 4536, 4554, 4572, 4590, 4608, 4626, 4644, 4662, 4680, 4698, 4716, 4734, 4752, 4770, 4788, 4806, 4824, 4842, 4860, 4878, 4896, 4914, 4932, 4950, 4968, 4986, 5004, 5022, 5040, 5058, 5076, 5094, 5112, 5130, 5148, 5166, 5184, 5202, 5220, 5238, 5256, 5274, 5292, 5310, 5328, 5346, 5364, 5382, 5400, 5418, 5436, 5454, 5472, 5490, 5508, 5526, 5544, 5562, 5580, 5598, 5616, 5634, 5652, 5670, 5688, 5706, 5724, 5742, 5760, 5778, 5796, 5814, 5832, 5850, 5868, 5886, 5904, 5922, 5940, 5958, 5976, 5994, 6012, 6030, 6048, 6066, 6084, 6102, 6120, 6138, 6156, 6174, 6192, 6210, 6228, 6246, 6264, 6282, 6300, 6318, 6336, 6354, 6372, 6390, 6408, 6426, 6444, 6462, 6480, 6498, 6516, 6534, 6552, 6570, 6588, 6606, 6624, 6642, 6660, 6678, 6696, 6714, 6732, 6750, 6768, 6786, 6804, 6822, 6840, 6858, 6876, 6894, 6912, 6930, 6948, 6966, 6984, 7002, 7020, 7038, 7056, 7074, 7092, 7110, 7128, 7146, 7164, 7182, 7200, 7218, 7236, 7254, 7272, 7290, 7308, 7326, 7344, 7362, 7380, 7398, 7416, 7434, 7452, 7470, 7488, 7506, 7524, 7542, 7560, 7578, 7596, 7614, 7632, 7650, 7668, 7686, 7704, 7722, 7740, 7758, 7776, 7794, 7812, 7830, 7848, 7866, 7884, 7902, 7920, 7938, 7956, 7974, 7992, 8010, 8028, 8046, 8064, 8082, 8100, 8118, 8136, 8154, 8172, 8190, 8208, 8226, 8244, 8262, 8280, 8298, 8316, 8334, 8352, 8370, 8388, 8406, 8424, 8442, 8460, 8478, 8496, 8514, 8532, 8550, 8568, 8586, 8604, 8622, 8640, 8658, 8676, 8694, 8712, 8730, 8748, 8766, 8784, 8802, 8820, 8838, 8856, 8874, 8892, 8910, 8928, 8946, 8964, 8982, 9000, 9018, 9036, 9054, 9072, 9090, 9108, 9126, 9144, 9162, 9180, 9198, 9216, 9234, 9252, 9270, 9288, 9306, 9324, 9342, 9360, 9378, 9396, 9414, 9432, 9450, 9468, 9486, 9504, 9522, 9540, 9558, 9576, 9594, 9612, 9630, 9648, 9666, 9684, 9702, 9720, 9738, 9756, 9774, 9792, 9810, 9828, 9846, 9864, 9882, 9900, 9918, 9936, 9954, 9972, 9990, 10008, 10026, 10044, 10062, 10080, 10098, 10116, 10134, 10152, 10170, 10188, 10206, 10224, 10242, 10260, 10278, 10296, 10314, 10332, 10350, 10368, 10386, 10404, 10422, 10440, 10458, 10476, 10494, 10512, 10530, 10548, 10566, 10584, 10602, 10620, 10638, 10656, 10674, 10692, 10710, 10728, 10746, 10764, 10782, 10800, 10818, 10836, 10854, 10872, 10890, 10908, 10926, 10944, 10962, 10980, 11000, 11020, 11040, 11060, 11080, 11100, 11120, 11140, 11160, 11180, 11200, 11220, 11240, 11260, 11280, 11300, 11320, 11340, 11360, 11380, 11400, 11420, 11440, 11460, 11480, 11500, 11520, 11540, 11560, 11580, 11600, 11620, 11640, 11660, 11680, 11700, 11720, 11740, 11760, 11780, 11800, 11820, 11840, 11860, 11880, 11900, 11920, 11940, 11960, 11980, 12000, 12020, 12040, 12060, 12080, 12100, 12120, 12140, 12160, 12180, 12200, 12220, 12240, 12260, 12280, 12300, 12320, 12340, 12360, 12380, 12400, 12420, 12440, 12460, 12480, 12500, 12520, 12540, 12560, 12580, 12600, 12620, 12640, 12660, 12680, 12700, 12720, 12740, 12760, 12780, 12800, 12820, 12840, 12860, 12880, 12900, 12920, 12940, 12960, 12980, 13000, 13020, 13040, 13060, 13080, 13100, 13120, 13140, 13160, 13180, 13200, 13220, 13240, 13260, 13280, 13300, 13320, 13340, 13360, 13380, 13400, 13420, 13440, 13460, 13480, 13500, 13520, 13540, 13560, 13580, 13600, 13620, 13640, 13660, 13680, 13700, 13720, 13740, 13760, 13780, 13800, 13820, 13840, 13860, 13880, 13900, 13920, 13940, 13960, 13980, 14000, 14020, 14040, 14060, 14080, 14100, 14120, 14140, 14160, 14180, 14200, 14220, 14240, 14260, 14280, 14300, 14320, 14340, 14360, 14380, 14400, 14420, 14440, 14460, 14480, 14500, 14520, 14540, 14560, 14580, 14600, 14620, 14640, 14660, 14680, 14700, 14720, 14740, 14760, 14780, 14800, 14820, 14840, 14860, 14880, 14900, 14920, 14940, 14960, 14980, 15000, 15020, 15040, 15060, 15080, 15100, 15120, 15140, 15160, 15180, 15200, 15220, 15240, 15260, 15280, 15300, 15320, 15340, 15360, 15380, 15400, 15420, 15440, 15460, 15480, 15500, 15520, 15540, 15560, 15580, 15600, 15620, 15640, 15660, 15680, 15700, 15720, 15740, 15760, 15780, 15800, 15820, 15840, 15860, 15880, 15900, 15920, 15940, 15960, 15980, 16000, 16020, 16040, 16060, 16080, 16100, 16120, 16140, 16160, 16180, 16200, 16220, 16240, 16260, 16280, 16300, 16320, 16340, 16360, 16380, 16400, 16420, 16440, 16460, 16480, 16500, 16520, 16540, 16560, 16580, 16600, 16620, 16640, 16660, 16680, 16700, 16720, 16740, 16760, 16780, 16800, 16820, 16840, 16860, 16880, 16900, 16920, 16940, 16960, 16980, 17000, 17020, 17040, 17060, 17080, 17100, 17120, 17140, 17160, 17180, 17200, 17220, 17240, 17260, 17280, 17300, 17320, 17340, 17360, 17380, 17400, 17420, 17440, 17460, 17480, 17500, 17520, 17540, 17560, 17580, 17600, 17620, 17640, 17660, 17680, 17700, 17720, 17740, 17760, 17780, 17800, 17820, 17840, 17860, 17880, 17900, 17920, 17940, 17960, 17980, 18000, 18020, 18040, 18060, 18080, 18100, 18120, 18140, 18160, 18180, 18200, 18220, 18240, 18260, 18280, 18300, 18320, 18340, 18360, 18380, 18400, 18420, 18440, 18460, 18480, 18500, 18520, 18540, 18560, 18580, 18600, 18620, 18640, 18660, 18680, 18700, 18720, 18740, 18760, 18780, 18800, 18820, 18840, 18860, 18880, 18900, 18920, 18940, 18960, 18980, 19000, 19020, 19040, 19060, 19080, 19100, 19120, 19140, 19160, 19180, 19200, 19220, 19240, 19260, 19280, 19300, 19320, 19340, 19360, 19380, 19400, 19420, 19440, 19460, 19480, 19500, 19520, 19540, 19560, 19580, 19600, 19620, 19640, 19660, 19680, 19700, 19720, 19740, 19760, 19780, 19800, 19820, 19840, 19860, 19880, 19900, 19920, 19940, 19960, 19980, 20000, 20020, 20040, 20060, 20080, 20100, 20120, 20140, 20160, 20180, 20200, 20220, 20240, 20260, 20280, 20300, 20320, 20340, 20360, 20380, 20400, 20420, 20440, 20460, 20480, 20500, 20520, 20540, 20560, 20580, 20600, 20620, 20640, 20660, 20680, 20700, 20720, 20740, 20760, 20780, 20800, 20820, 20840, 20860, 20880, 20900, 20920, 20940, 20960, 20980, 21000, 21020, 21040, 21060, 21080, 21100, 21120, 21140, 21160, 21180, 21200, 21220, 21240, 21260, 21280, 21300, 21320, 21340, 21360, 21380, 21400, 21420, 21440, 21460, 21480, 21500, 21520, 21540, 21560, 21580, 21600, 21620, 21640, 21660, 21680, 21700, 21720, 21740, 21760, 21780, 21800, 21820, 21840, 21860, 21880, 21900, 21920, 21940, 21960, 21980, 22000, 22020, 22040, 22060, 22080, 22100, 22120, 22140, 22160, 22180, 22200, 22220, 22240, 22260, 22280, 22300, 22320, 22340, 22360, 22380, 22400, 22420, 22440, 22460, 22480, 22500, 22520, 22540, 22560, 22580, 22600, 22620, 22640, 22660, 22680, 22700, 22720, 22740, 22760, 22780, 22800, 22820, 22840, 22860, 22880, 22900, 22920, 22940, 22960, 22980, 23000, 23020, 23040, 23060, 23080, 23100, 23120, 23140, 23160, 23180, 23200, 23220, 23240, 23260, 23280, 23300, 23320, 23340, 23360, 23380, 23400, 23420, 23440, 23460, 23480, 23500, 23520, 23540, 23560, 23580, 23600, 23620, 23640, 23660, 23680, 23700, 23720, 23740, 23760, 23780, 23800, 23820, 23840, 23860, 23880, 23900, 23920, 23940, 23960, 23980, 24000, 24020, 24040, 24060, 24080, 24100, 24120, 24140, 24160, 24180, 24200, 24220, 24240, 24260, 24280, 24300, 24320, 24340, 24360, 24380, 24400, 24420, 24440, 24460, 24480, 24500, 24520, 24540, 24560, 24580, 24600, 24620, 24640, 24660, 24680, 24700, 24720, 24740, 24760, 24780, 24800, 24820, 24840, 24860, 24880, 24900, 24920, 24940, 24960, 24980, 25000, 25020, 25040, 25060, 25080, 25100, 25120, 25140, 25160, 25180, 25200, 25220, 25240, 25260, 25280, 25300, 25320, 25340, 25360, 25380, 25400, 25420, 25440, 25460, 25480, 25500, 25520, 25540, 25560, 25580, 25600, 25620, 25640, 25660, 25680, 25700, 25720, 25740, 25760, 25780, 25800, 25820, 25840, 25860, 25880, 25900, 25920, 25940, 25960, 25980, 26000, 26020, 26040, 26060, 26080, 26100, 26120, 26140, 26160, 26180, 26200, 26220, 26240, 26260, 26280, 26300, 26320, 26340, 26360, 26380, 26400, 26420, 26440, 26460, 26480, 26500, 26520, 26540, 26560, 26580, 26600, 26620, 26640, 26660, 26680, 26700, 26720, 26740, 26760, 26780, 26800, 26820, 26840, 26860, 26880, 26900, 26920, 26940, 26960, 26980, 27000, 27020, 27040, 27060, 27080, 27100, 27120, 27140, 27160, 27180, 27200, 27220, 27240, 27260, 27280, 27300, 27320, 27340, 27360, 27380, 27400, 27420, 27440, 27460, 27480, 27500, 27520, 27540, 27560, 27580, 27600, 27620, 27640, 27660, 27680, 27700, 27720, 27740, 27760, 27780, 27800, 27820, 27840, 27860, 27880, 27900, 27920, 27940, 27960, 27980, 28000, 28020, 28040, 28060, 28080, 28100, 28120, 28140, 28160, 28180, 28200, 28220, 28240, 28260, 28280, 28300, 28320, 28340, 28360, 28380, 28400, 28420, 28440, 28460, 28480, 28500, 28520, 28540, 28560, 28580, 28600, 28620, 28640, 28660, 28680, 28700, 28720, 28740, 28760, 28780, 28800, 28820, 28840, 28860, 28880, 28900, 28920, 28940, 28960, 28980, 29000, 29020, 29040, 29060, 29080, 29100, 29120, 29140, 29160, 29180, 29200, 29220, 29240, 29260, 29280, 29300, 29320, 29340, 29360, 29380, 29400, 29420, 29440, 29460, 29480, 29500, 29520, 29540, 29560, 29580, 29600, 29620, 29640, 29660, 29680, 29700, 29720, 29740, 29760, 29780, 29800, 29820, 29840, 29860, 29880, 29900, 29920, 29940, 29960, 29980, 30000, 30020, 30040, 30060, 30080, 30100, 30120, 30140, 30160, 30180, 30200, 30220, 30240, 30260, 30280, 30300, 30320, 30340, 30360, 30380, 30400, 30420, 30440, 30460, 30480, 30500, 30520, 30540, 30560, 30580, 30600, 30620, 30640, 30660, 30680, 30700, 30720, 30740, 30760, 30780, 30800, 30820, 30840, 30860, 30880, 30900, 30920, 30940, 30960, 30980, 31000, 31020, 31040, 31060, 31080, 31100, 31120, 31140, 31160, 31180, 31200, 31220, 31240, 31260, 31280, 31300, 31320, 31340, 31360, 31380, 31400, 31420, 31440, 31460, 31480, 31500, 31520, 31540, 31560, 31580, 31600, 31620, 31640, 31660, 31680, 31700, 31720, 31740, 31760, 31780, 31800, 31820, 31840, 31860, 31880, 31900, 31920, 31940, 31960, 31980

at the relationship between 288 and 468. In the middle of the page, he adds 2 to the hundreds digit in 288 and subtracts two from the tens digit, which gives him 468. He repeats the process again to get 648.

At this point, Feliciano and I talked about why this worked. Feliciano couldn't articulate the divisibility test for 9, but he was working with it intuitively when he found 468 and 648. After we talked about how the digits needed to add up to 18, he was able to find all of the other combinations, which are scattered around the page. I'm glad I got the chance to see how this problem worked with a student who was skilled in math. Feliciano was engaged with the problem, and he enjoyed getting to learn and talk about the divisibility test.

Final Thoughts

I really liked the way this problem played out in class. For most of the students, this was only the second problem-solving activity that they had done. Because they were new to struggling with math problems, I hoped that working on this one would encourage persistence and help them to come up with strategies for organization. For the most part, we met those goals. We also took the time to talk about the patterns that appear in multiples of 9, as well as the divisibility test, which is shown in the board work at the right. Through working on this problem and its extensions, I learned that with enough preparation, there are interesting questions that can be asked about any mathematical idea—even one as basic as multiples.

9 -	99 → 18	189 → 18	279 → 18
18 → 9	108 → 9	198 → 18	288 → 18
27 → 9	117 → 9	207 → 9	882, 828
36 → 9	126 → 9	216 → 9	Find all the multiples of 9 that are less than 1,000 and have only eleven digits. 288, 882, 828
45 → 9	135 → 9	225 → 9	
54 → 9	144 → 9	234 → 9	
63 → 9	153 → 9	243 → 9	
72 → 9	162 → 9	252 → 9	
81 → 9	171 → 9	261 → 9	
90 → 9	180 → 9	270 → 9	

■ What I Might Change

I wouldn't change much about how I did this problem. If I do it again early in the cycle, though, I might try reviewing the different problem-solving strategies that we had discussed before doing this problem. That way, students would have to make a more conscious choice between using a table/chart and trying to guess and check. Unfortunately, this time, a handful of students spun their wheels guessing and checking when they could have used a more effective method. Still, I think they benefited somewhat from doing it the "wrong way" before moving on to a better way.

I might also give out hundreds charts to students who really struggle with their times tables. It could help them to get started, and it could also help them to identify a pattern that will help them remember their nines in the future. And lastly, if I do this problem early in a class cycle again, I might ask students to write a reflection of what it was like working on the problem.

■ Unexpected Challenges

I gave this problem again in another class—one with a wider range of math levels—and found that it was a little difficult to manage all of the students. Some students finished the problem quickly, while others needed me to sit with them and keep them working, give them feedback on their work, etc. This made it challenging to keep the higher-level students engaged while still supporting the students who needed individual attention.

■ Student Takeaways

My students liked this problem, and it fit in well with the work on factors and multiples that we were doing in class earlier in the week. They enjoyed trying out and discussing some of the problem-solving strategies that we had been working on as a class. They also got to hear about different solution methods from their peers, and they had the opportunity to share their frustrations with the problem, as well as the sequence of steps they took to break through that frustration. For one student in particular—Jean Marie—this problem was a major breakthrough. For the first time in class, she stuck with something, got angry at it, settled back down, tried again, failed, tried again, and finally succeeded. She hasn't given up on a problem since. This is a great exercise to do with students who need to learn how to stick with something. It has a low entry point, but the discussion can go a lot of different ways.

My students were also able to see the importance of pattern recognition in math. Recognizing the patterns for multiples of 9 helped several students write out all of the multiples quickly, rather than adding repeatedly. After we finished this activity, “Look for a pattern” was added to our list of problem-solving strategies, and it has since helped students succeed in other difficult problems.

■ Advice for Teachers

This is a good low-entry problem for students who are new to your class, but it could be used at any point in the cycle as a warmup exercise. Teachers should be prepared for students to get frustrated and give up, but they should also be prepared with extra questions for students who breeze through the exercise. The problem works

best if you allow plenty of time for the class as a whole to debrief, especially because students need to see that there is a bigger takeaway from doing the problem than just crunching numbers. And there's a lot of rich territory on which to have that discussion. Talk about organizing information, talk about patterns, talk about divisibility tests, and emphasize key vocabulary. Help your students understand that their struggle was a productive one.

The Gold Rush Problem

The Problem:

In 1848, gold was discovered at Sutter's Mill in California. Over the next several years, hundreds of thousands of prospectors traveled westward hoping to make their fortunes mining gold.

A man named Billy Merrell happened to own some of the land where the gold was discovered. Instead of digging the gold himself, he decided to rent plots of land to the prospectors. Billy gave each prospector four wooden stakes and a rope measuring exactly 100 meters in length. Each prospector then had to use the stakes and the rope to mark off a rectangular plot of land.

1 Assuming that each prospector would like to have the biggest possible plot, what should the dimensions of each plot be? Explain the reasoning behind your answer in a sentence or two.

2 One prospector noticed an advertisement that Billy had posted on his land. It read: "Join the ropes together! You can get more land if you work together!"

Investigate whether or not this statement is actually true for two or more prospectors who work together and divide the plot equally, still using just four stakes.

Explain your answer in a few sentences.

from Math Assessment Project (map.mathshell.org)

How I Solved It

This is an optimization problem. Let x and y be the dimensions of the rectangular plot. Given the constraint of only having 100 meters of rope, the perimeter of my plot would be $2x + 2y = 100$. The area would be $A = xy$. I started by solving the perimeter equation for y so that I could substitute it into the equation for area.

$$\begin{array}{r} 2x + 2y = 100 \\ -2x \quad \quad -2x \\ \hline 2y \quad \quad = 100 - 2x \\ \frac{2y}{2} \quad \quad = \frac{100 - 2x}{2} \\ \hline y = 50 - x \end{array}$$

Substituting this into the equation for area, I have $A = x(50 - x)$, or $A = 50x - x^2$. The graph of this equation will be a parabola with a single

critical point, and that critical point will give me the x -value that will maximize area. To find that point, I need to know the derivative of A with respect to x ; this will be the equation for slope of the tangent line to the graph. The critical point I'm looking for will have a tangent line with slope 0.

The derivative of my area formula is $A' = 50 - 2x$, where A' represents the slope of the tangent line at a chosen point. Since I'm trying to find the point where the slope is zero, I substitute 0 for A' . Now I have $0 = 50 - 2x$. When I solve this for x , I get the solution $x = 25$ meters. So this is the optimal length, which means that my optimal width is also 25 meters. The shape that will maximize area is a square that is 25 meters by 25 meters.

To answer the second part of the question, I applied the same rationale to a rope that is now 200 meters in length. If the optimal shape is a square, then it would be 50 meters by 50 meters, and it would have an area of 2500 square meters. This means that each prospector would get 1250 square meters of land, which is twice as much as they would have before. So it does make sense to "join the ropes."

Other Ways to Solve This Problem

The method I outlined above is impractical for teaching, and I only tried it to challenge myself and to see if I could remember how optimization problems worked. So after solving it algebraically, I wanted to examine the relationship between area and perimeter just so that I could see how much the area changed when I made slight modifications to the dimensions. I drew a few different rectangles and ended up at the square that was my final answer from before.

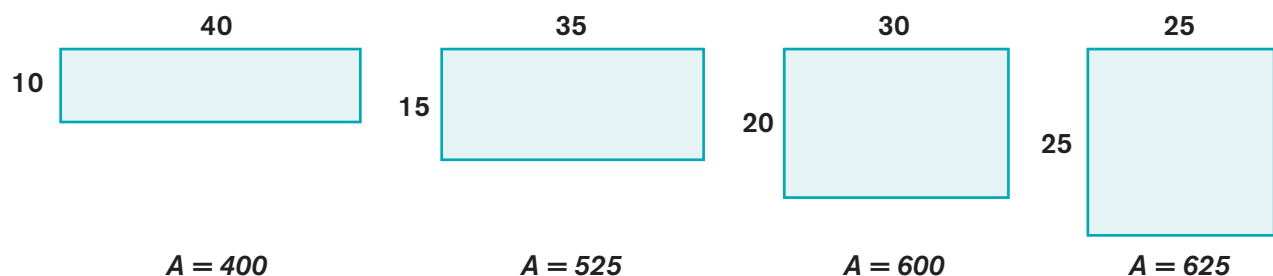

The pattern I noticed when drawing the rectangles out in this order—from long and skinny to square—showed me that as a shape becomes closer in form to a square, the area increases.

I also wrote it out in table form, just so that I could have an organized chart showing the areas given by different dimensions. I started the table at 40 by 10, as shown below, and worked my way up.

Length	Width	Area
40	10	400
39	11	429
38	12	456
37	13	481
36	14	504
35	15	525
34	16	544
33	17	561
32	18	576
31	19	589
30	20	600
29	21	609
28	22	616
27	23	621
26	24	624
25	25	625
24	26	624

The table is interesting because it provides the opportunity to see the consecutive difference in area each time that the dimensions are adjusted by 1 meter. I noticed a pattern, which is added in the updated table below:

Length	Width	Area	Consec. Diff.
40	10	400	+29 = 429
39	11	429	+27 = 456
38	12	456	+25 = 481
37	13	481	+23 = 504
36	14	504	+21 = 525
35	15	525	+19 = 544
34	16	544	+17 = 561
33	17	561	+15 = 576
32	18	576	+13 = 589
31	19	589	+11 = 600
30	20	600	+9 = 609
29	21	609	+7 = 616
28	22	616	+5 = 621
27	23	621	+3 = 624
26	24	624	+1 = 625
25	25	625	MAX
24	26	624	-1 = 624

Why I Chose This Problem

I chose the gold rush problem because it is similar to a problem that I had used in my class before; the version I used involved maximizing the area of a garden given a limited amount of available fencing to surround the garden. What I liked about the gold rush problem is that it took the garden problem a step further by asking students to analyze what happens to area when perimeter is doubled, tripled, etc, and I like how it invites different strategies for solving. I also like how this problem encourages creative thinking about basic shapes. It invites students to construct several different rectangles, which ideally will lead them to a better understanding of how dimensions relate to perimeter. Doing this also reinforces computation skills, and so it works well in a multilevel classroom. Once students arrive at their answers, there is a lot to talk about. For example, is a square a rectangle? Is a rectangle a square? Assuming that I did share a plot of land with another prospector, what would be the most equitable way to split it? Do we split the land, or do we split the profits? At what point in joining the ropes together does the workload become too much for one prospector? And so on.

And finally, there's a bit of historical context here, and so it fits well into a class that also has a history component. It acts as a good springboard into a discussion about the pre-Civil War period and the waves of westward migration that were occurring around the time.

Why This Is a DOK 3 Problem

Depending on how the problem is used and what you're asking your students to produce in the end, this could actually be a DOK 4 problem. At DOK 4, students are essentially completing a research project that allows them to draw a conclusion not just about a specific situation, but about a mathematical concept in general. In this case, the students first have to read and understand a situation that might not be immediately clear to them. From here, they have to think creatively about how they might get started. They then perform some basic calculations, but they also have to keep in mind that they're looking to maximize area while keeping perimeter the same. This attention to multiple constraints and geometric concepts requires some higher-level thinking than a standard DOK 1 or 2 question in which students might just be asked to calculate the area of a shape (level 1), or calculate the area of a shape given its perimeter (level 2).

My Goal for Student Learning

One goal in presenting this problem is that my students will be able to apply the basic concepts of area and perimeter in a setting that is a little different from what they might be used to. I also hope to see that they're able to think creatively about the problem and make adjustments to the shape of their plots in order to see how the shape of the rectangle has a significant effect on its area. In other words, I want them to be able to create a possible plot but then—without my intervention—try drawing other rectangles as a way of checking to see if their answer is correct. Another goal is for students to verbalize the relationship between the shape of a rectangle and its area. What the students should notice is that, as the rectangles become more square-like, the area increases. I also would like to see an organized approach to solving this problem, although I realize that the way students organize their work will differ greatly.

Challenges for Students

I anticipate a number of students drawing one rectangle and thinking that they've answered the question after they've successfully calculated its area. Moreover, I anticipate some resistance when I prompt them to try drawing other rectangles so that they can compare the areas of each. I also anticipate some issues with understanding the situation. Even though the prompt specifically mentions rectangular plots, I have a feeling that some students will miss this part. They'll understand that they're getting four stakes and a rope, but they won't really know where to go from there. So I might have to intervene a bit just to clarify exactly what the question is asking them today. I also foresee students jumping to a quick conclusion about the second part of the question. That is, I think that some will gloss over the part about joining two ropes together and just assume that because you're sharing with another prospector, you would get less land.

To support students who are struggling, I will first ask them to tell me what is happening in the problem. I would want to make sure that they understand exactly what they're getting from Billy and why they are getting those materials. If they are unable to make a rectangle, I might ask them to draw one, and then I would ask what the length of the rectangle could be. They could then try a few things and check their work. For students who try to stop after drawing one rectangle, I'll ask how they know that the one they drew provides the most land to work with. So after they try one more, I'll ask that they try another. And so on. I have some students in my class who really struggle to do long multiplication, and so I may allow them to use calculators. The goal of this activity is to encourage reasoning about shapes; it's not about

crunching numbers.

Extension Questions

If some students finish early, I would ask what would happen if three, four, or five people joined their ropes together. How much land would each person get in these cases? And is there a pattern to the increase in land you get by working together with other prospectors? How could you organize the data to see what the pattern might be? Could this be viewed as an input/output table, or a function? If so, what would be the rule of the function? How do you know? How many ropes would you need to join together so that you could get 7500 square meters to work with?

Student Work

ELISA AND BELEN'S APPROACH

Belen is one of the brightest students in the class. Elisa struggles and has missed several classes because of her work schedule and other issues. This group had a hard time getting started, but once they figured out a pattern, they were able to make progress. What I like about their representation is how organized it is. They begin with a rectangle that is 30 meters by 20 meters; it has an area of 600. The next rectangle they drew had dimensions of 28 by 22, with an area of 616. When I talked to B. and E. about this, they said that they were surprised about what happened to the area. They explained that they noticed how, when they decreased the length and increased the width, the area got bigger. So they kept doing this until they arrived at the dimensions 26 by 24, for an area of 624. This was the greatest area possible, they said.

When I asked why they didn't go a step further and try 25 by 25, they reasoned that it wasn't allowed: The plot had to be a rectangle, and 25 by 25 would be a square. I was interested in this solution because I predicted that students would get hung up on the square/rectangle issue, and these two were adamant that the plot could not be a square. So we talked about this. Also, notice their reasoning at the bottom. It says, "After a while we figure it out that if you increase the width, then you have to decrease the length in order to have the same perimeter, but bigger Area." I understood what they meant, but we talked about it for a while to get some clarification. Is there a point at which decreasing length and increasing width doesn't increase area anymore? What is that point? Why does it work this way? This group's graphical approach was typical of what other students tried.

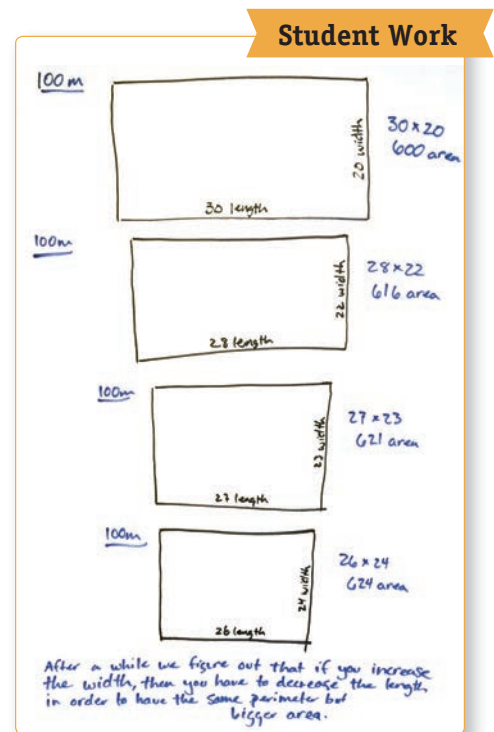

TRAVIS AND LATOYA'S APPROACH

What interested me about this group's approach was that the first rectangle they drew was actually correct. But they didn't know that. So I prompted them to try drawing a few others. Travis was sure that he could find one with a greater area, because he reasoned that as the length value got bigger and bigger, the area would too. He wasn't really thinking multiplicatively yet. So he tried some other rectangles: 40 by 10, 20 by 30, and 45 by 5. He told me that he was really surprised to find that the 45 meter by 5 meter rectangle had the smallest area. So he, Latoya, and I went into a hallway that was about 5 feet wide and looked at how narrow this would actually be.

Travis and Latoya were able to complete the second part of the question pretty quickly. Latoya said that she knew the shape would need to be a square again, since the square from part 1 had a bigger area than the rectangles. They did some calculations and concluded: "It would be better to join the ropes because you can make your width and length wider by each side. By doing this you increase your profit. There is also more land for you and your partner to dig." I was really interested in the comment about profit, and so we talked about it with the whole group. We wondered whether having more land would necessarily guarantee more profit. So in talking about this, we touched on probability, and we also began thinking about what the most equitable way of sharing the plot would be. Is it more fair to split the land, or is it more fair to split the total profit? Most of the students concluded that it would be the most fair to split the total profit, or weight in gold, equally. Though some said they would prefer to take a gamble and have half of the land all to themselves. This was interesting, I thought.

1)

$25 \times 25 = 625$
 $40 \times 10 = 400$
 $20 \times 30 = 600$
 $45 \times 5 = 225$
 $10 \times 40 = 400$

2)

$50 \times 50 = 2500$
 2500

It would be better to join the ropes because you can make your width and length wider by each side. By doing this you increase your profit. There is also more land for you and your partner to dig.

Student Work

RODOLFO, CLEMENTE, AND JULIO'S APPROACH

Rodolfo and Julio have been with me for a while, but Clemente is pretty new. All have limited English proficiency, and so it was fascinating to me that their description of how they solved this problem was the most verbal of any that I saw. What isn't clear from this photo is that, before they submitted this poster, they had done another that contained pictures and nothing else. I told them that I would like to know more about what they had to say about the problem, meaning that I would like them to talk about it to the group. They decided to start over and take the approach you see above.

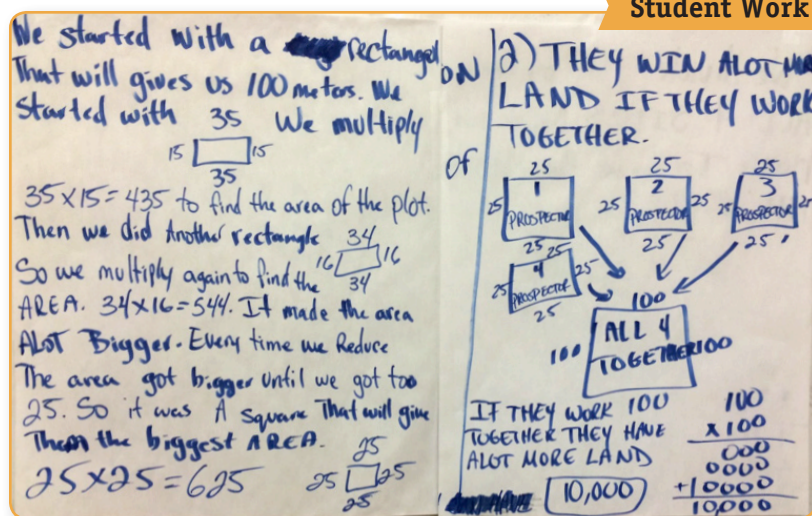

After finishing part 1, Rodolfo was sure that there was no way it would be beneficial to work with another prospector. So I asked him to prove it to me, and he started working. When I checked back with their table only three or four minutes later, Rodolfo told me that he was wrong: If he worked with another prospector, he would get twice as much land. Because they answered so quickly, I asked: "What if all four of us decided to join our ropes together? How much land would we get then?" And they produced the explanation on the right. Their drawing is interesting. It suggests that the four small squares could be put together to form the big square with area of 10,000 square meters. I asked them about this. They explained to the group that they didn't mean it that way, and they realized how their drawing didn't accurately represent their thinking. This approach to presenting their solution was great and not at all what I was expecting.

CRYSTAL AND STEVEN'S APPROACH

I liked Crystal's approach because of its clarity and simplicity. But it's also worth noting that Crystal needs almost constant support in the classroom. She has a hard time struggling on her own, and her hand shoots up to ask for my help once every five minutes or so. When she first looked at this problem, she gave up right away and said that she didn't have any idea where to start. So we first just talked about what was happening in the problem. Once Crystal figured out that she needed to make a rectangular plot, she was able to produce the four rectangles above. And she worked independently for the next fifteen minutes

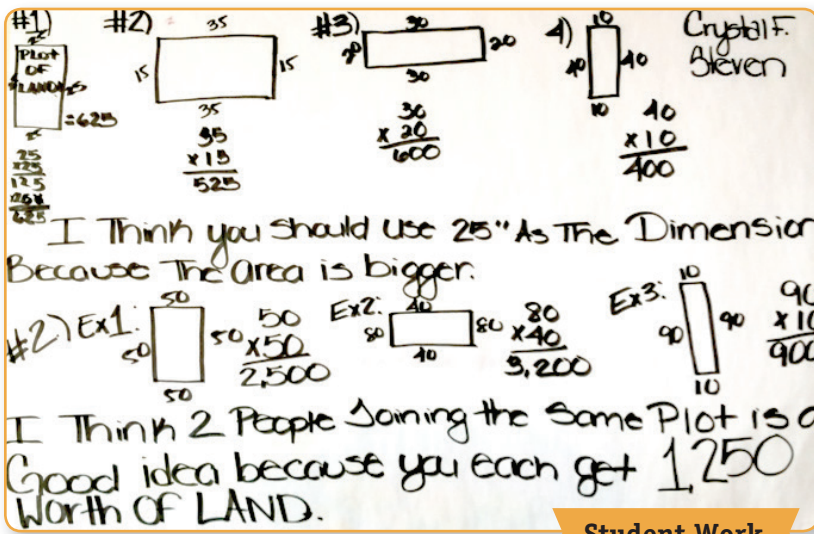

without asking a single question. After a few tries, she arrived at the correct answer.

Steven was really struggling. Despite some help and some tips from me, he wasn't able to find any rectangles that had a perimeter of 100 meters. The only one he could come up with was 25 by 25. This was good, but I wanted to see some flexibility in how he was thinking about this, so I pushed him to keep trying. Crystal was sitting next to him, and when I stepped away to

talk to another student, she started showing Steven what she had been working on. Steven followed along with what she was saying and asked her questions. I thought this was a really great moment for Crystal. Here was a student who had no confidence in her own abilities, teaching another student how to create rectangles. I also noticed that Steven was really listening. So I stayed out of the way, and they finished the project together, with Crystal doing most of the heavy lifting and Steven asking good questions along the way.

Final Thoughts

I really enjoyed doing this problem with my classes, and it's one that I would highly recommend using with any class level. I wasn't whether or not to have small groups present their strategies to the class using posters, but I'm really glad I did. In some cases, I was explicit with students in asking them to represent all of the steps they took to get to their answers—meaning, I wanted to see the mistakes as well as the successes. But with other groups, I just let them go. I found this to be an effective way of structuring the discussion about student responses. By doing this, we got to talk about different ways of structuring and illustrating our thinking, but we also got to talk about the choices that the students made in terms of what to include and what to take out when creating their posters. Over the past two years, a big part of my teaching has involved talking about student work, and this activity only reinforced it for me. Time spent talking about thinking and talking about strategy is just as valuable as time spent solving equations or graphing lines. I also learned a lot about my students' ability to persevere and struggle from doing this activity. I do at least one of these long-form problems every week, and at the beginning of the

cycle, my students tended to give up, get frustrated, and ask me why I was making them do problems like this. But now that we've done ten or twelve of them, my students have become real problem-solvers. It was affirming to see that we can teach persistence and that our students do benefit from it.

■ What I Might Change

When I did the problem this time, I asked my students to work independently for about twenty minutes, but then I allowed them to work with the other people at their table for the next forty minutes. I think that this improved the “presentation” element of working on this problem, but I would be interested in seeing what would happen if students just work independently the entire time. I plan to try this next time around, just to see what I get from them. My sense is that the small-group work facilitated some good discussion, and it helped keep struggling students engaged. Even if they weren't able to completely solve the problem on their own, they were able to provide input and feedback as the group worked together. I'm also interested in trying this activity over a period of a week. Students could submit something on the first day. I would then provide some feedback and ask them to clarify their thinking in places, and I would ask them to resubmit their work. I'd like to see how their explanations and processes would change if they were given several days, rather than just an hour, to think and elaborate.

■ Unexpected Challenges

I used this problem with two groups of students who didn't have a lot of experience with geometry. Most of them were able to pick up on area and perimeter quickly—in large part because it wasn't completely new—but some had a hard time. I can think of two or three students who just couldn't figure out how to make a rectangle have a perimeter of 100 meters. Or, if they were able to find one, then they couldn't find one with different dimensions. In these cases, I just asked the students to focus on creating rectangles, not finding the one with the biggest area: “Calculating the area can wait; for now, let's just see how many different rectangles we can find that have the perimeter we're looking for.” Next time I'll be better prepared to help students with this part of the problem.

■ Student Takeaways

My students really liked this problem, and they liked getting the opportunity to explain how they solved it. The students did learn some important mathematical concepts, but I think that the most

important thing they got out of it was thinking about how they would create their posters so that they could talk about their thinking. They learned that they needed to show the beginning and intermediary steps before just getting to the answer because this would help their classmates understand where the approach came from and how they worked with it. Through the course of the activity, I saw my students start to think like teachers. When talking about their strategies, they explained all their steps and they fielded questions, both from me and from their peers.

■ Advice for Teachers

This is a great problem that gives students a lot of material to talk about. On the surface, it just seems like another word problem, but there are lots of extension questions you could pose to encourage further thinking, and there are good discussions that can arise after the students have already found the solution. So don't feel like you have to rush through it. Take your time, talk to your students about their thinking, and then ask them to show their thinking to their peers. You'll also get a sense of what your students are interested in. Mine, for example, were really interested in turning this into a function (because we had just covered functions). Each student will find something interesting about this problem. So take a little bit of time to let the class go where they want it to go. Your students will appreciate it.

The Movie Theater Problem

The Problem:

At a movie theater in Windsor Terrace, the price of a children's ticket is 50 percent of the price of an adult's ticket. Nick and Katie (both adults) took their three children to see a movie yesterday, and the total for all the tickets was \$36.75. What was the price of each child's ticket?

Please show all your work, and circle your final answer.

How I Solved It

I solved this problem algebraically. Let x be the price of each child's ticket. An adult's ticket costs twice as much as a child's ticket, so the price of each adult's ticket would be $2x$. There are two adults, and so the total price for their tickets would be $2x + 2x$, or $4x$. There are three children, and so their total ticket price would be $3x$. The total for all tickets would therefore be $4x + 3x$, or $7x$. This should be equal to the amount paid, \$36.75. So:

$$7x = 36.75$$

$$x = 5.25$$

A child's ticket costs \$5.25.

Other Ways to Solve This Problem

One possibility would be guess and check. Let's assume that a child's ticket is \$6.00. If this were true, then the total for the children would be 3 times \$6.00, or \$18.00. Since the adult tickets cost twice as much, and there are two adults, the adults paid \$12.00 times 2, or \$24.00. The total for this scenario would be \$42.00, which is too high. I could keep adjusting my guess until I get the correct result.

I could also put this information into a table, which would help me to organize my guesses. Let's say I started by guessing that a child's ticket is \$4.00, and then I recorded each subsequent guess into the table. It might look something like this:

Child's Ticket	Adult's Ticket	Total Cost
$\$4.00 \times 3 = \12.00	$\$8.00 \times 2 = \16.00	$\$12.00 + \$16.00 = \$28.00$
$\$5.00 \times 3 = \15.00	$\$10.00 \times 2 = \20.00	$\$15.00 + \$20.00 = \$35.00$
$\$6.00 \times 3 = \18.00	$\$12.00 \times 2 = \24.00	$\$18.00 + \$24.00 = \$42.00$
$\$5.50 \times 3 = \16.50	$\$11.00 \times 2 = \22.00	$\$16.50 + \$22.00 = \$38.50$
$\$5.25 \times 3 = \15.75	$\$10.50 \times 2 = \21.00	$\$15.75 + \$21.00 = \$36.75$

Why Did You Choose This Problem? What Do You Like About It?

I like the problem because even though the situation is easy to understand, solving the problem is difficult. Because my students aren't familiar with algebra yet, they'll have to puzzle it out using a bit of guessing and exercising precision and control over basic operations. I've noticed throughout the cycle that this group of students does very well with calculation and that they don't have too much trouble working out rather complex problems when the methods required are clear to them. However, they struggle when they have to puzzle things out for themselves, especially when there are no given answers to choose from. Had I given this problem the first week of class, I probably could have expected most of my students to come up with an incorrect answer. Now that we've had a bit more practice with problem solving, though, I expect to see far more correct answers. And finally, this question requires close reading, which is what my students struggle with the most. I deliberately made the wording in the first part a little more confusing than it needed to be, which will require them to think carefully about how the two ticket prices are related. They'll also be thrown by the percent figure in there, and I'm guessing that a number of students will try to apply formulas like the percent proportion, which probably won't be of much help here. The question requires a more comprehensive understanding of what percent means. I'll also be interested to see how many "correct" answers I get that give me the price of an adult's ticket instead of a child's ticket.

Why Is This a Good Problem?

I think this problem is a good fit for this particular group, and it will help my students to persevere in problem solving. The problem has at least a couple of different solution methods, and it requires a synthesis of basic operations, close reading, and checking the answer. It requires several steps in that the students will have to correctly identify the number of adults and the number of children and then perform a few

rounds of basic operations. It requires also reasoning and inference in that the students should use their own knowledge of the world to assume that a child's ticket likely wouldn't cost something like \$1.50 or \$22.00; common sense should help the students to arrive at an answer. Students will definitely have to think about what the question is asking before jumping right in, because in a sense they'll be working backward from the total to determine the cost of the "parts." I think that this requires a holistic approach to the concepts, in that they'll see how the basic operations relate to each other and to common, everyday settings. This question also requires careful reading, and most students will need to read it at least two or three times to really get a handle on it. Lastly, this problem definitely invites the use of a few different problem-solving strategies. I'm assuming most students will use guess-and-check; they'll draw pictures; they'll work backwards; and they'll look for patterns as they try these strategies.

Challenges for Students

■ Reading

As I noted above, my students have more difficulty with understanding the question than with performing calculations. I anticipate that some will simply assume all the ticket prices are the same; others might misinterpret the number of people seeing the movie; and others might return the price of an adult ticket instead of a child's ticket.

■ Puzzling out an answer

This group has a hard time digging into really difficult problems when the answer choices aren't given to them. I think that this problem will make them try a few different methods or guesses to arrive at the answer. Some might get frustrated in doing this and might just give up.

■ Checking their answer and making sure it makes sense

As with most of the students I teach at this level, this group has a tendency to come up with an answer and then just go with it, without making sure that it makes sense or that it actually checks out. When I see the student work, I'm hoping to see that at least a few people went back and made sure their answer was correct.

Support

- **I will emphasize careful reading and ask good clarifying questions.** If a student is struggling, I'll read through the question with them and make sure that they understand both the criteria set forth in the problem and exactly what it is that the question is asking them. This will help to set them on the right track in terms of figuring out how to solve the problem.
- **"I don't know where to start."** This is something that I hear a lot, and when this happens during this activity, I'll ask what the student thinks the answer could be. So, if a student is really struggling with this problem, I'll ask that they start by taking a guess at what the cost of a child's ticket will be, then I'll see where that takes them.
- **I will need to help students think about their answers and whether or not they make sense.** I plan to ask students how they can be sure that their answer is correct and asking that they prove their answers to me. This will show me that they really understand the question and why their answer is correct.

Student Work

LINDA'S APPROACH

Linda is perhaps the brightest student in the class, but because her English-speaking and reading skills aren't too good, she sometimes gets hung up on problems with confusing wording. Her work on this exercise exemplified this problem. I knew when I included a mention of "50 percent" in the question that students would first try to use the percent proportion to solve; this was Linda's approach. She found that 50 percent of 36.75 was equal to 18.375, and it was hard for her to let go of this number. Once she got it, she divided it by three and assumed that each child's ticket must be \$6.125. She was then convinced that this had to be part of the answer. Linda's work—and her failure to solve the problem correctly—showed both me and her how much she needs to work on creative approaches to problem solving. Linda immediately associated the percent figure with the percent proportion that we worked on in class, and then couldn't understand how it could be wrong. She feels comfortable working with formulas and struggles when they don't always work out.

1 Why did you choose this sample of work?

As I mentioned above, this sample shows a problem that Linda has struggled with all semester. She doesn't like to take guesses, draw pictures, or work backwards. She likes to fall back on the formulas that she has memorized, and when those don't work out, she freezes and can't understand how her answer could be wrong, no matter how much I try to lead her into thinking about the problem more comprehensively. Linda's work shows a student who sees numbers, plugs them into what she knows, and thinks that it should result in the correct answer, which, most of the time for Linda, it does. Oddly, Linda also started asking people across the room for clues, which is something I've never seen her do. When I would turn my back to her and work with someone else, I would hear her whispering to other students asking how they got the answer. It really shows how uncomfortable she gets when her formulas don't work.

2 How typical was this student's approach in your class?

Very typical. Of the seven students who tried the exercise, all seven started by finding 50 percent of \$36.75. Most of the others, however, realized that this approach wasn't getting them anywhere and then moved on. Linda had a hard time with this, even when I changed the wording of the question to say that "an adult's ticket cost twice as much as a child's ticket." Although I thought that changing the wording might affect Linda's thinking—which it did for many of the other students—she still couldn't shake the notion that 50 percent of \$36.75 had something to do with the answer.

RUBEN'S APPROACH

From Ruben's work, it's difficult to tell exactly how his thinking is organized, which I found interesting. He began by dividing 36.75 by 5, and came up with an answer of \$7.35. When I pressed him on that answer and asked if everything checked out, he was confident that it did. But then when I asked him if the adults and the children all paid the same price for tickets, he recognized his mistake. Then, like Linda, he found 50 percent of the total ticket cost, but he seems to have realized fairly quickly that it wasn't working. Unlike Linda, though, he continued to try to puzzle out an answer by labeling different numbers and by repeating values for the ticket prices for the adults and for the children. Ruben was not able to come up with the correct answer.

1 Why did you choose this sample of student work?

I primarily chose it because of the student. Ruben isn't very strong mathematically, but in general he has a good head on his shoulders and enough real-world experience using math that he's able to come up with correct answers, or at least strong guesses. In two consecutive classes, he passed both both forms of the TASC Readiness Test. This surprised me, in large part because Ruben's in-class work usually looks like it did on this exercise; that is, he tends to just jump into a problem and plug in numbers. So I found this example of work interesting because it seems like Ruben doesn't really have a plan, but he has consistently scored well on all assessments he's given in class, which tells me that I must be missing something. This kind of disorganized work is something that I warn students against in class, but Ruben doesn't seem able to break the habit—and maybe that's okay. To my mind, organization seems essential to doing math, and through his work Ruben is making me call that idea into question. Or maybe we just have different ideas of organization.

2 How typical was this student's approach in your class?

Fairly atypical. In most of the samples I collected, the students seemed to really consider things for a long time before writing anything down, and even then, they didn't write much. Ruben just went right for it and worked with just about any number he could find. By far, he wrote more and tried more than any other student.

ARI'S APPROACH

Like Ruben and Linda, one of the first things Ari did was calculate 50 percent of the total ticket price. She appears to have abandoned that idea pretty quickly though. She then did what Ruben did and divided 36.75 by 5 to get \$7.35. This is where Ari made an interesting mistake: she began calculating 50 percent of 7.35, and then tried to work with the resulting value, \$3.67, as the child's ticket price. At this point she got stuck and asked for some guidance. When we checked her answer against the criteria set forth in the question, she saw that her answer was wrong and decided to try something else and started guessing. As you see at the bottom of her page, she tried a few different child's ticket prices and then calculated the totals, adjusting her guesses as necessary until she arrived at the correct answer.

1 Why did you choose this sample of student work?

Ari was the only student who answered this question correctly on her own, and she was the second student to come up with an

answer after Ruben's initial incorrect one. In all, it took her about ten minutes. Everyone else in the class labored over the problem for more than a half hour and needed a good deal of guidance to come up with an answer. When Ari got the answer of \$5.25, she was also confident in it and was able to prove that it was correct using her calculator. Ari came into the class pretty unsure of herself, but she has become a great student and a leader in the classroom. Her ability to try different methods and be confident in her answer shows really reflects her growth as a learner.

2 How typical was this student's approach in your class?

Initially, it was typical. Ari was hung up on the numbers given to her in the problem and fell back on the mathematical methods that she would normally use to solve a problem. But when she realized that those didn't work, she felt comfortable stepping away from them and making a guess. Soon after her first incorrect guess, she realized that she would get to the correct answer using the guess-and-check strategy and continued working until she came up with the answer. Very few other students felt comfortable guessing, and even when I recommended that they try it, those students were resistant.

Final Thoughts

I learned that even though I have adopted more of a problem-solving approach to the teaching of math in this course, I still have a ways to go. My students' relative inability to puzzle out an answer to this problem showed me that they still have a long way to go in terms of being problem solvers. They did a good job mathematically, which shows me that I've at least done a reasonably effective job of teaching computation, but their work on this problem evidence a real lack of comprehensive understanding of mathematical concepts—in this case, percent. I mentioned this in my workshop reflection, and it was made concrete in class when I gave my students this problem.

All of this showed reminded me that teaching computation is such a small part of the battle in HSE math. I'm now thinking that the best thing to do is to work on fewer problems in class and instead really work hard on just a few problems, emphasizing the deep connections between concepts. It's great for students to see and work on a wide variety of problems, but if the conceptual understanding is missing, they still won't be able to solve difficult problems like this one on their own.

■ What I Might Change

I think that in changing the wording to involve a mention of percent, I made this problem a little too difficult. Next time, I might try saying that an adult ticket costs twice as much as a child's ticket and then see where my students take it. Another thought I had is that we could have a discussion as a class about what the 50 percent means in the context of the question. Does it mean that the children's tickets were 50 percent of the total cost? How can we connect 50 percent to a fraction? What do we need to calculate 50 percent of? And so on.

■ Student Takeaways

I think that there is a great benefit in applying something that you know you know only to learn that it doesn't always work out the way you think it should. In this case, almost everyone jumped straight to the percent proportion, because it so often does help them to get to the correct answer, even if it's only a step along the way. Here, falling back on the formula they had been using all semester actually did them a disservice in solving this problem. It is my hope that working on this problem for the length of time that they did helped them to understand that they sometimes need to be a little bit more creative.

It also really emphasized close reading, which is something that all of my students have identified as something they need to work on. Several students came up with answer that added up to \$36.75, but they ignored the criteria that a child's ticket costs half as much as an adult's ticket. While it's important to know what the question is asking and to focus your efforts toward answering it, it's also important to keep the constraints in mind.

■ Unexpected Challenges

I really didn't think they would have quite as much trouble working with and understanding the constraint built into the problem—that children's tickets cost half as much as adult tickets. Several of them were able to come up with answers, but no student—save perhaps Ari—showed me a correct answer on their first try. It was also difficult to nudge students away from calculating 50 percent of the total ticket price without giving too much away. And then when I did, and when I encouraged them to try making a guess, they would kind of roll their eyes and dismiss the suggestion, because I think that many of my students see guessing and checking as “not real math.” They want to know a more concrete, more typically “mathematical” method. So this is something that I will try to build on more before I give this question in the future.

■ Advice for Teachers

I would recommend that a teacher first give the problem exactly as it is written, just to see what students are able to come up with. But then, I think it's important to carefully structure the clues given to the students as they continue struggling, and it's just as important to reinforce problem-solving strategies. I might also recommend leading with a less confusingly worded constraint; the teacher could then discuss other ways that the constraint could be written. For example, each student could say that a child's ticket is half as much as an adult's, or that each adult's ticket is twice as much as a child's, or that an adult's ticket costs 100% more than a child's ticket. This might be an interesting way to reinforce concepts.

Guessing and checking got a few people to the right answer, but that was the only method that worked. After the first twenty minutes to a half hour, I put five answer choices on the board and told them that one of those answers was exactly correct. At this point, the students started to remember that they could try each one against the constraints set forth in the question—which, at this point, we had gone over together as a group to make sure that everyone was on the same page—and they came up with the answer. I was pleased to see that they were able to work backwards, but when I teach that solution method next semester, I'll be sure to do a better job of linking it to guessing and checking.

It might also be interesting, once students have arrived at the correct answer, to have them create a similar question of their own and then solve it. Or it might also be good to have students write new questions based on the values in the question and the answer. I like to emphasize that doing math is a creative process, and I often have students write their own problems based on the concepts covered in class that day. I haven't, however, had them use information from an existing question—one that they had solved—to come up with something unique. I think I'll try that next time.

“ Education is what happens to the other person, not what comes out of the mouth of the educator. ”

—Myles Horton

Math Resources

The resources here are divided up into **Books, Articles/Reports** and **Web Resources**. Use the chart to get a sense of how each resource might best support your work. Any resource that is marked **“About Teaching”** is focused on both the art and the craft of teaching. **“About Math Content”** are resources for teachers who are interested in deepening their own content knowledge of mathematics. **“Problems”** are resources that have quality tasks and activities that can be used with adult education math students. Any resource in any of those three categories could be used for professional development, but the resources marked **“Professional Development”** are ones that have specific activities and discussion questions for teachers to do and talk about together.

Included after the chart are additional web resources that support math teachers.

BOOKS

BOOK TITLE	ABOUT TEACHING	ABOUT MATH CONTENT	PROBLEMS	PROFESSIONAL DEVELOPMENT
<i>About Teaching Mathematics</i> , by Marilyn Burns				
<i>5 Practices for Orchestrating Productive Mathematics Discussions</i> , by Margaret S. Smith and Mary Kay Stein				
<i>Fostering Geometric Thinking: A Guide for Teachers, Grades 5-10</i> , by Mark Driscoll				
<i>The Art of Problem Posing</i> , by Stephen I. Brown and Marion I. Walter				
<i>Math Matters</i> , by Suzanne Chapin and Art Johnson				
<i>Knowing and Teaching Elementary Mathematics</i> , by Liping Ma				
<i>The Teaching Gap</i> , by James Stigler and James Hiebert				
<i>Fostering Algebraic Thinking: A Guide for Teachers, Grades 6-10</i> by Mark Driscoll				
<i>What's Math Got To Do With It?</i> , by Jo Boaler				
<i>A Collection of Math Lessons from Grades 6 through 8</i> , by Marilyn Burns and Cathy Humphreys				
<i>Lessons for Algebraic Thinking Grades 3 through 5</i> , by Maryann Wickett, Katharine Kharas and Marilyn Burns				
<i>Lessons for Algebraic Thinking Grades 6-8</i> , by Ann Lawrence and Charlie Hennessy				
<i>Elementary and Middle School Mathematics: Teaching Developmentally</i> , by John A. Van De Wall, Karen S. Karp, and Jennifer M. Bay-Williams				

BOOK TITLE	ABOUT TEACHING	ABOUT MATH CONTENT	PROBLEMS	PROFESSIONAL DEVELOPMENT
The entire <i>EMPower</i> series by Mary Jane Schmitt, Myriam Steinback, Donna Curry, Tricia Donovan and Martha Merson				
<i>Every Minute Counts: Making Your Math Class Work and Making Minutes Count Even More</i> , by David R. Johnson				
<i>Classroom Discussions: Using Math Talk to Help Students Learn, Grades 1-6</i> , by Suzanne H. Chapin, Catherine O'Connor and Nancy Canavan Anderson				
<i>Principles to Actions: Ensuring Mathematical Success For All</i> – National Council of Teachers of Mathematics				
<i>A Problem-Solving Approach to Mathematics for Elementary School Teachers</i> , by Rick Billstein				

ARTICLES/REPORTS

ARTICLE / REPORT TITLE	ABOUT TEACHING	ABOUT MATH CONTENT	PROBLEMS	PROFESSIONAL DEVELOPMENT
<i>13 Rules that Expire</i> , by Karen S. Karp, Sarah B. Bush, and Barbara J. Dougherty				
<i>Algebraic Thinking in Adult Education</i> , by Myrna Manly and Lynda Ginsburg				
<i>Improving Learning in Mathematics: Challenges and Strategies</i> , by Malcolm Swan				
<i>The Thinking of Students: The Three Bears Cookie Store</i> , by Edward S. Mooney				
<i>Three Balloons for Two Dollars: Developing Proportional Reasoning</i> , by Cynthia W. Langrall and Jane Swafford				
<i>Mathematical Tasks as a Framework for Reflection: From Research to Practice</i> , by Mary Kay Stein and Margaret Schwan Smith				
<i>Fostering Relational Thinking while Negotiating the Meaning of the Equals Sign</i> , by Marta Molina and Rebecca C. Ambrose				
<i>Promoting Algebraic Reasoning Using Student Thinking</i> , by Joyce W. Bishop, Albert D. Otto and Cheryl A. Lubinski				
<i>Big Ideas and Understandings as the Foundation for Elementary and Middle School Mathematics</i> , by Randall I. Charles				
<i>A World of Difference</i> , by James Hiebert and James W. Stigler				

ARTICLE / REPORT TITLE	ABOUT TEACHING	ABOUT MATH CONTENT	PROBLEMS	PROFESSIONAL DEVELOPMENT
<i>Orchestrating Discussions</i> , by Margaret S. Smith, Elizabeth K. Hughes, Randi A. Engle and Mary Kay Stein				
<i>Characteristics of Japanese Mathematics Lessons</i> , by Akihiko Takahashi				
<i>Redefining Success in Math Teaching and Learning</i> , by Margaret Schwan Smith				
<i>Turning Traditional Textbook Problems into Open-Ended Problems</i> , by Mary S. Kabiri and Nancy L. Smith				
<i>Selecting and Creating Math Tasks: From Research to Practice</i> , by Mary Schwan Smith and Mary Kay Stein				
<i>Never Say Anything a Kid Can Say</i> , by Steven Reinhart				
A Can of Coke Leads to a Piece of Pi, by Marilyn Burns				
<i>Improving Middle School Teachers Reasoning and Proportional Reasoning</i> , by Charles Thompson and William S. Bush				
Teachers Investigating Adult Numeracy Bundles (available online at http://tian.terc.edu)				
<i>Developing Algebraic Thinking Through Pattern Exploration</i> , by Lesley Lee and Viktor Freiman				
<i>Math Works! Guide</i> , by the Teacher Excellence in Adult Literacy (TEAL) Center				
<i>Problem-Solving as a Basis for Reform in Curriculum and Instruction: The Case of Mathematics</i> by James Hiebert, Thomas P. Carpenter, Elizabeth Fennema, Karen Fuson, Piet Human, Hunlie Murray, Alwyn Olivier, Diana Wearne				

WEB RESOURCES

■ [Visualpatterns.org](http://visualpatterns.org)

Visual Patterns is a very simple and wonderful website, created by a public middle school teacher in Southern California named Fawn Nguyen. The site is essentially a collection of 157 different visual patterns (and growing). For each pattern, you are given the first three figures/stages of the pattern.

■ CollectEDNY.org

CollectEDNY offers a wealth of free, quality teaching resources vetted and reviewed by adult education instructors for adult education instructors. Teachers can also post comments sharing experiences and asking questions about the teaching material.

■ [Mathmistakes.org](http://mathmistakes.org)

A wonderful website edited by Michael Pershan, a middle and high school math teacher. Teachers send in photos of student mistakes they find fascinating, confounding and/or mysterious. Michael posts it on the site and then teachers can discuss in the comment section. Teacher comments tend to focus on analyzing the thinking, identifying the assumptions behind the work, strategies for responding, what the next steps could be, etc.

■ insidemathematics.org

This is a professional resource for educators passionate about improving students' mathematics learning and performance. The goal of the site is to help educators continue to grow and transform their teaching practice. The site includes lessons, challenging math problems, videos of classroom instruction, videos of teachers planning lessons, videos of teachers reflecting on lessons they just taught, etc.

■ illustrativemathematics.org

This is a great resource that brought together teachers, math educators and mathematicians to create mathematical tasks aligned to each standard of the Common Core. There are currently over 1000 tasks, from grades K through 12. Because it is K-12, some tasks will need to be adapted, but there are rich materials for adult education students at all levels, from ABE to HSE.

■ [Math Assessment Project—http://map.mathshell.org](http://map.mathshell.org)

The project has the goal of providing well-engineered assessment tools for implementing the Common Core State Standards for Mathematics. To meet this goal, the MAP website covers three major content areas: formative assessment, summative assessment, and professional development. The best place to start is with the formative assessment lessons, which are called Classroom Challenges. These classroom challenges are separated by grade level and divided into two different sections: concept development lessons and problem-solving lessons.

■ [Which One Doesn't Belong?—http://wodb.ca](http://wodb.ca)

WODB is a website with a very simple concept. It is “dedicated to providing thought-provoking puzzles for math teachers and students alike.” Basically, it presents four of something and you have to come up with a reason why each one of the four things doesn't belong.

■ [Dan Meyer's Three-Act Math Tasks—http://blog.mrmeyer.com/2011/the-three-acts-of-a-mathematical-story/](http://blog.mrmeyer.com/2011/the-three-acts-of-a-mathematical-story/)

This web site shares interesting problems designed to be rolled out in three stages (or acts). The goal is to help students develop initiative, perseverance and retention while working to answer questions they have posed in response to real-world problems.

■ **Fawn Nguyen’s Blog—Fawnnguyen.com**

Fawn Nguyen is a middle school math teacher in California. Finding Ways is where she tells stories that are mainly about teaching and learning mathematics in the classroom. Her blog is filled with great problems and activities, engaging commentary and photos of student thinking and a contagious love of teaching math.

■ **101 Questions—101qs.com**

The premise is simple. Go to the site and a photo or video will appear. You are asked to write the first question that comes to your head. Then repeat. But dig a little deeper and you will find math teachers who have created lessons, activities and Three-Act Math Tasks using many of those photos and videos. This site is also a great way for teachers to create their own Three-Act Math Tasks.

■ **Estimation180.com—“Building number sense one day at a time.”**

Each day of the school year Andrew Stadel presents his students with an estimation challenge. His goal is to help students improve both their number sense and problem solving skills. This website is his platform to share the estimation challenges for other teachers to use with their students.

■ **Openmiddle.com**

Inspired by Dan Meyers, this web site shares problems with an “open middle.” This means that they have a closed beginning (start with the same initial problem), have a closed end (one answer), but there are multiple ways to approach and ultimately solve each problem.

■ **Would You Rather?—wyrmath.wordpress.com**

This blog collects Would You Rather... questions for students, which we students will have to consider, then justify their answers. The dilemmas posed include lottery lump-sum payments versus monthly payments, choice of lines in the supermarket, coupon discounts, leasing or buying a car, etc.

■ **Desmos.com**

This free online calculator allows you to graph functions, plot tables of data, and evaluate equations. If you create an account, you can also save your work and export formulas and graphs.

■ **CUNY Framework Posts—<http://www.collectedny.org/frameworkposts/>**

In the CUNY Framework Posts section of CollectEdNY, teachers can find materials to extend the lessons in the CUNY HSE Curriculum Framework as well as to provide additional support and practice for students. Teachers can also find lessons/problems/readings/teaching materials for content that is not contained within the CUNY HSE Framework.